

IAMSAR Manual

INTERNATIONAL AERONAUTICAL AND
MARITIME SEARCH AND RESCUE MANUAL

Volume III
MOBILE FACILITIES

incorporating 2001, 2002, 2003, 2004,
2005, 2006 and 2007 amendments



IMO/ICAO
London/Montréal, 2008

Published jointly in 2008 by the
INTERNATIONAL MARITIME ORGANIZATION
4 Albert Embankment, London SE1 7SR, United Kingdom
and the
INTERNATIONAL CIVIL AVIATION ORGANIZATION
999 University Street, Montréal, Québec, Canada H3C 5H7

First edition 1998
Second edition 2003
Third edition 2004
Fourth edition 2005
Fifth edition 2006
Sixth edition 2007
Seventh edition 2008

This edition printed in Canada by ICAO

ISBN 978-92-9231-287-9

ICAO PUBLICATION
ICAO sales number: 9731P3

Copyright © IMO/ICAO 2008

All rights reserved.
No part of this publication may be reproduced,
stored in a retrieval system or transmitted
in any form or by any means,
without prior permission in writing from the
International Maritime Organization or
the International Civil Aviation Organization.

Foreword

The primary purpose of the three volumes of the *International Aeronautical and Maritime Search and Rescue Manual* is to assist States in meeting their own search and rescue (SAR) needs and the obligations they accepted under the Convention on International Civil Aviation, the International Convention on Maritime Search and Rescue, and the International Convention for the Safety of Life at Sea (SOLAS). These volumes provide guidelines for a common aviation and maritime approach to organizing and providing SAR services. States are encouraged to develop and improve their SAR services; to co-operate with neighbouring States and to consider their SAR services to be part of a global SAR system.

Each IAMSAR Manual volume is written with specific SAR system duties in mind, and can be used as a stand-alone document, or, in conjunction with the other two volumes, as a means to attain a full view of the SAR system.

- The *Organization and Management* volume (volume I) discusses the global SAR system concept, establishment and improvement of national and regional SAR systems, and co-operation with neighbouring States to provide effective and economical SAR services;
- The *Mission Co-ordination* volume (volume II) assists personnel who plan and co-ordinate SAR operations and exercises; and
- The *Mobile Facilities* volume (volume III) is intended to be carried aboard rescue units; aircraft, and vessels to help with performance of a search, rescue, or on-scene co-ordinator function and with aspects of SAR that pertain to their own emergencies.

This Manual is published jointly by the International Civil Aviation Organization and the International Maritime Organization.

Since it was published in 1998, this volume has been amended by the 2001 amendments (adopted by ICAO and by the IMO Maritime Safety Committee at its seventy-fourth session in June 2001, and entered into force on 1 July 2002), by the 2002 amendments (adopted by ICAO and by the seventy-fifth session of the IMO Committee in May 2002, and entered into force on 1 July 2003), by the 2003 amendments (adopted by ICAO and by the seventy-seventh session of the IMO

Foreword

Committee in June 2003, and entered into force on 1 July 2004), by the 2004 amendments (adopted by ICAO and by the seventy-eighth session of the IMO Committee in May 2004, and entered into force on 1 July 2005), by the 2005 amendments (adopted by ICAO and by the eightieth session of the IMO Committee, and entered into force on 1 June 2006) and by the 2006 amendments (adopted by ICAO and by the eighty-first session of the IMO Committee, and entered into force on 1 June 2007). It has also been amended to reflect the changes to chapter V of SOLAS 1974 that were adopted in December 2000 (entered into force on 1 July 2002) and in May 2004 (entered into force on 1 July 2006).

This new edition includes the 2007 amendments (adopted by ICAO and by the Maritime Safety Committee (MSC) at its eighty-third session in October 2007 that enter into force on 1 June 2008. The amendments have also been endorsed by the Sub-Committee on Radiocommunications and Search and Rescue (COMSAR) at its eleventh session in February 2007.

Contents

Abbreviations and Acronyms	vii
Glossary	xi
Section 1: Overview	1-i
Section 2: Rendering Assistance	2-i
Section 3: On-Scene Co-ordination	3-i
Section 4: On-Board Emergencies	4-i
Appendices	
Appendix A: Regulation V/33 of the International Convention for the Safety of Life at Sea, 1974, as amended	A-1
Appendix B: Search Action Message	B-1
Appendix C: Factors Affecting Observer Effectiveness	C-1
Appendix D: Standard Format for Search and Rescue Situation Report (SITREP)	D-1
Appendix E: SAR Briefing and Debriefing Form	E-1

C

C

C

Abbreviations and Acronyms

A	search area
A/C	aircraft
ACO	aircraft co-ordinator
AM	amplitude modulation
ATC	air traffic control
ATS	air traffic services
CES	coast earth station
CIRM	Centro Internazionale Radio-Medico
CRS	coast radio station
C/S	call sign
CS	creeping line search
CSC	creeping line search, co-ordinated
CSP	commence search point
CW	continuous wave
DF	direction finding
DMB	datum marker buoy
DR	dead reckoning
DSC	digital selective calling
ELT	emergency locator transmitter
EPIRB	emergency position-indicating radio beacon
ETA	estimated time of arrival
ETD	estimated time of departure
F/V	fishing vessel
FM	frequency modulation
f_w	weather correction factor
GES	ground earth station
GHz	gigahertz

Abbreviations and Acronyms

GMDSS	global maritime distress and safety system
GPS	global positioning system
GS	ground speed
gt	gross tonnage
HF	high frequency
ICAO	International Civil Aviation Organization
IFR	instrument flight rules
IMC	instrument meteorological conditions
IMO	International Maritime Organization
IMSO	International Mobile Satellite Organization
Inmarsat	satellite communication service provider for the GMDSS
INTERCO	International Code of Signals
JRCC	joint (aeronautical and maritime) rescue co-ordination centre
kHz	kilohertz
kt	knot (nautical mile per hour)
LCB	line of constant bearing
LES	land earth station
LKP	last known position
LUT	local user terminal
LW	leeway
m	metre
M/V	merchant vessel
MCC	mission control centre
MEDEVAC	medical evacuation
MEDICO	medical advice, usually by radio
MF	medium frequency
MHz	megahertz
MRO	mass rescue operations
MSI	maritime safety information

NBDP	narrow-band direct printing
NM	nautical mile
OSC	on-scene co-ordinator
PIW	person in water
PLB	personal locator beacon
POB	persons on board
PS	parallel sweep search
R	search radius
R/T	radio telephony
RANP	regional air navigation plan
RCC	rescue co-ordination centre
RSC	rescue sub-centre
RTG	radio telegraphy
RTT	radio teletype
S	track spacing
S/V	sailing vessel
SAR	search and rescue
SART	search and rescue radar transponder
SC	search and rescue co-ordinator
SES	ship earth station
SITREP	situation report
SMC	search and rescue mission co-ordinator
SOLAS	Safety of Life at Sea
SRR	search and rescue region
SRS	search and rescue sub-region
SRU	search and rescue unit
SS	expanding square search
SSB	single-sideband
SU	search unit

Abbreviations and Acronyms

T	search time available
T	true course
TAS	true air speed
TS	track line search
TSN	track line search, non-return
UHF	ultra high frequency
UTC	co-ordinated universal time
V	SAR facility ground speed
VFR	visual flight rules
VHF	very high frequency
VMC	visual meteorological conditions
VS	sector search
WT	radio telegraph

Glossary

Aircraft co-ordinator (ACO)	A person or team who co-ordinates the involvement of multiple aircraft in SAR operations in support of the SAR mission co-ordinator and on-scene co-ordinator.
Amver	A world-wide ship reporting system for search and rescue.
Captain	Master of a ship or pilot-in-command of an aircraft, commanding officer of a warship, or an operator of any other vessel.
Coast earth station (CES)	Maritime name for an Inmarsat shore-based station linking ship earth stations with terrestrial communications networks.
Commence search point (CSP)	Point, normally specified by the SMC, where a SAR facility is to begin its search pattern.
Conclusion stage	A period during a SAR incident when SAR facilities return to their regular location and prepare for another mission.
Cospas-Sarsat System	A satellite system designed to detect distress beacons transmitting on the frequencies 121.5 MHz and 406 MHz.
Course	The intended horizontal direction of travel of a craft.
Craft	Any air or sea-surface vehicle, or submersible of any kind or size.
Datum	A geographic point, line, or area used as a reference in search planning.
Digital selective calling (DSC)	A technique using digital codes which enables a radio station to establish contact with, and transfer information to, another station or group of stations.
Direction of waves, swells, or seas	Direction from which the waves, swells, or seas are moving.
Direction of wind	Direction from which the wind is blowing.

Distress alert	Notification by any means that a distress situation exists and assistance is needed.
Ditching	The forced landing of an aircraft on water.
Drift	Movement of a search object caused by environmental forces.
Emergency locator transmitter (ELT)	Aeronautical radio distress beacon for alerting and transmitting homing signals.
Emergency position-indicating radio beacon (EPIRB)	A device, usually carried aboard maritime craft, that transmits a signal that alerts search and rescue authorities and enables rescue units to locate the scene of the distress.
False alarm	Distress alert initiated for other than an appropriate test, by communications equipment intended for alerting, when no distress situation actually exists.
False alert	Distress alert received from any source, including communications equipment intended for alerting, when no distress situation actually exists, and a notification of distress should not have resulted.
Fetch	The distance the waves have been driven by a wind blowing in a constant direction, without obstruction.
Global maritime distress and safety system (GMDSS)	A global communications service based upon automated systems, both satellite-based and terrestrial, to provide distress alerting and promulgation of maritime safety information for mariners.
Heading	The horizontal direction in which a craft is pointed.
Hypothermia	Abnormal lowering of internal body temperature (heat loss) from exposure to cold air, wind, or water.

Inmarsat	A system of geostationary satellites for world-wide mobile communication services and support of the GMDSS and other emergency communication systems.
Leeway	The movement of a search object through water caused by winds blowing against exposed surfaces.
Mass Rescue Operation (MRO)	Search and rescue services characterized by the need for immediate response to large numbers of persons in distress, such that the capabilities normally available to search and rescue authorities are inadequate.
MAYDAY	Spoken international distress signal, repeated three times.
MEDEVAC	Evacuation of a person for medical reasons.
MEDICO	Medical advice. Exchange of medical information and recommended treatment for sick or injured persons where treatment cannot be administered directly by prescribing medical personnel.
Narrow-band direct printing (NBDP)	Automated telegraphy, as used by the NAVTEX system and telex-over-radio.
NAVAREA	One of 16 areas into which the world's oceans are divided by the International Maritime Organization for dissemination of navigation and meteorological warnings.
NAVTEX	The system for the broadcast and automatic reception of maritime safety information by means of narrow-band direct-printing telegraphy.
On-scene	The search area or the actual distress site.
On-scene co-ordinator (OSC)	A person designated to co-ordinate search and rescue operations within a specified area.

PAN-PAN	The international radiotelephony urgency signal. When repeated three times, indicates uncertainty or alert, followed by nature of urgency.
Primary swell	The swell system having the greatest height from trough to crest.
Rescue	An operation to retrieve persons in distress, provide for their initial medical or other needs, and deliver them to a place of safety.
Rescue action plan	A plan for rescue operations normally prepared by the SMC for implementation by the OSC and facilities on-scene.
Rescue co-ordination centre (RCC)	A unit responsible for promoting efficient organization of search and rescue services and for co-ordinating the conduct of search and rescue operations within a search and rescue region.
Rescue sub-centre (RSC)	A unit subordinate to a rescue co-ordination centre established to complement the latter according to particular provisions of the responsible authorities.
SafetyNET	A service of Inmarsat enhanced group call (EGC) system specifically designed for promulgation of maritime safety information (MSI) as a part of the Global Maritime Distress and Safety System (GMDSS).
Sea	Condition of the surface resulting from waves and swells.
Search	An operation, normally co-ordinated by a rescue co-ordination centre or rescue sub-centre, using available personnel and facilities to locate persons in distress.
Search action plan	Message, normally developed by the SMC, for passing instructions to SAR facilities and agencies participating in a SAR mission.

Search and rescue mission co-ordinator (SMC)

The official temporarily assigned to co-ordinate response to an actual or apparent distress situation.

Search and rescue region (SRR)

An area of defined dimensions, associated with a rescue co-ordination centre, within which search and rescue services are provided.

Search and rescue unit (SRU)

A unit composed of trained personnel and provided with equipment suitable for the expeditious conduct of search and rescue operations.

Search and rescue radar transponder (SART)

A survival craft transponder that, when activated, sends out a signal automatically when a pulse from a nearby radar reaches it. The signal appears on the interrogating radar screen and gives the bearing and distance of the transponder from the interrogating radar for search and rescue purposes.

Swell

Condition of the surface caused by a distant wind system. The individual swell appears to be regular and smooth with considerable distance between rounded crests.

Swell direction

The direction from which a swell is moving. The direction toward which a swell is moving is called the direction swell.

Swell face

The side of the swell toward the observer. The back side is the side away from the observer. These definitions apply regardless of the direction of swell movement.

Swell velocity

Velocity with which the swells advance with relation to a fixed point, measured in knots.

Track spacing (S)

The distance between adjacent parallel search tracks.

True air speed (TAS)

The speed an aircraft is travelling through the air mass. TAS corrected for wind equals ground speed.

Wave (or chop)

The condition of the surface caused by local wind and characterized by irregularity, short distance between crests, whitecaps, and breaking motion.

Wind current

The water current generated by wind acting upon the surface of water over a period of time.



Section 1 – Overview

Contents

Purpose	1-1
Responsibilities and Obligations to Assist	1-1
National and Regional SAR System Organization	1-1
SAR Co-ordination	
SAR Co-ordinators	1-2
SAR Mission Co-ordinator	1-2
On-Scene Co-ordinator	1-3
Ship Reporting Systems	
Amver	1-4
Aircraft Reporting System	1-5
Underwater search and rescue	1-5

C

C

C

Section 1 – Overview

Purpose

The purpose of the *International Aeronautical and Maritime Search and Rescue Manual for Mobile Facilities*, which is intended for carriage aboard search and rescue units, and aboard civil aircraft and vessels, is to provide guidance to those who:

- operate aircraft, vessels or other craft, and who may be called upon to use the facility to support SAR operations
- may need to perform on-scene co-ordinator functions for multiple facilities in the vicinity of a distress situation
- experience actual or potential emergencies, and may require search and rescue (SAR) assistance.

Responsibilities and Obligations to Assist

Under long-standing traditions of the sea and various provisions of international law, ship masters are obligated to assist others in distress at sea whenever they can safely do so.

The responsibilities to render assistance to a distressed vessel or aircraft are based on humanitarian considerations and established international practice. Specific obligations can be found in several conventions, including the following:

- Annex 12 to the **Convention on International Civil Aviation**
- **International Convention on Maritime Search and Rescue**
- Regulation V/33 of the **International Convention for the Safety of Life at Sea, 1974 (SOLAS 1974)**. (See appendix A).

National and Regional SAR System Organization

Many States have accepted the obligation to provide aeronautical and maritime SAR co-ordination and services on a 24-hour basis for their territories, territorial seas, and where appropriate, the high seas.

- To carry out these responsibilities, States have established national SAR organizations, or joined one or more other States to form a regional SAR organization associated with an ocean area or continent.

- A search and rescue region (SRR) is an area of defined dimensions associated with a rescue co-ordination centre (RCC) within which SAR services are provided.
 - SRRs help to define who has primary responsibility for co-ordinating responses to distress situations in every area of the world, but they are not intended to restrict anyone from assisting persons in distress
 - the International Civil Aviation Organization (ICAO) regional air navigation plans (RANPs) depict aeronautical SRRs
 - the International Maritime Organization (IMO) Global SAR Plan depicts maritime SRRs.

SAR Co-ordination

The SAR system has three general levels of co-ordination:

- SAR co-ordinators (SCs)
- SAR mission co-ordinators (SMCs)
- On-scene co-ordinators (OSCs).

■ SAR Co-ordinators

- SCs are the top level SAR managers; each State normally will have one or more persons or agencies for whom this designation may be appropriate.
- SCs have the overall responsibility for:
 - establishing, staffing, equipping and managing the SAR system
 - establishing RCCs and rescue sub-centres (RSCs)
 - providing or arranging for SAR facilities
 - co-ordinating SAR training
 - developing SAR policies.

■ SAR Mission Co-ordinator

- Each SAR operation is carried out under the guidance of an SMC. This function exists only for the duration of a specific SAR incident and is normally performed by the RCC chief or a designee. The SMC may have assisting staff.
- The SMC guides a SAR operation until a rescue has been effected or it becomes apparent that further efforts would be of no avail.

- The SMC should be well trained in all SAR processes, be thoroughly familiar with the applicable SAR plans, and:
 - gather information about distress situations
 - develop accurate and workable SAR action plans
 - dispatch and co-ordinate the resources to carry out SAR missions.
- SMC duties include:
 - obtain and evaluate all data on the emergency
 - ascertain the type of emergency equipment carried by the missing or distressed craft
 - remain informed of prevailing environmental conditions
 - if necessary, ascertain movements and locations of vessels and alert shipping in likely search areas for rescue, lookout and/or radio watch
 - plot the areas to search and decide on methods and facilities to be used
 - develop the search action plan and rescue action plan as appropriate
 - co-ordinate the operation with adjacent RCCs when appropriate
 - arrange briefing and debriefing of SAR personnel
 - evaluate all reports and modify search action plan as necessary
 - arrange for refuelling of aircraft and, for prolonged search, make arrangements for the accommodation of SAR personnel
 - arrange for delivery of supplies to sustain survivors
 - maintain in chronological order an accurate and up-to-date record
 - issue progress reports
 - determine when to suspend or terminate the search
 - release SAR facilities when assistance is no longer required
 - notify accident investigation authorities
 - if applicable, notify the State of registry of the aircraft
 - prepare a final report.

■ **On-Scene Co-ordinator**

- When two or more SAR facilities are working together on the same mission, one person on-scene may be needed to co-ordinate the activities of all participating facilities.

- The SMC designates an OSC, who may be the person in charge of a:
 - search and rescue unit (SRU), ship, or aircraft participating in a search, or
 - nearby facility in a position to handle OSC duties.
- The person in charge of the first facility to arrive at the scene will normally assume the OSC function until the SMC arranges for that person to be relieved.

Ship Reporting Systems

- Ship reporting systems have been established by several States.
- Ships at sea may be the only craft near the scene of a distressed aircraft or vessel.
- A ship reporting system enables the SMC to quickly:
 - identify vessels in the vicinity of a distress situation, along with their positions, courses, and speeds
 - be aware of other information about the vessels which may be valuable (whether a doctor is aboard, etc.)
 - know how to contact the vessels
 - improve the likelihood of rapid aid during emergencies
 - reduce the number of calls for assistance to vessels unfavourably located to respond
 - reduce the response time to provide assistance.
- Masters of vessels are urged or *mandated* to send regular reports to the authority operating a ship reporting system for SAR and other safety-related services.
- Additional information on operators of ship reporting systems may be obtained from RCCs.

■ Amver

Amver is one of *many* ship reporting systems. It is a world-wide system operated exclusively to support SAR and make information available to all RCCs.

- There is no charge for vessels to participate in, nor for RCCs to use, Amver.
- Many land-based providers of communications services world-wide relay ship reports to Amver free of charge.

- Any merchant vessel of 1000 gross tons or more on any voyage of greater than 24 hours is welcome to participate.
- Information voluntarily provided by vessels to Amver is protected by the US Coast Guard as commercial proprietary data and made available only to SAR authorities or others specifically authorized by the ship involved.

Aircraft Reporting System

- Aircraft typically rely upon air traffic services (ATS) units for flight following and communications services.
- Pilots are encouraged to file flight plans with the appropriate ATS unit to ensure expeditious response to an emergency.

Underwater search and rescue

- In the event a mobile facility has reason to suspect that an underwater accident has occurred, every effort should be made to contact the nearest Rescue Co-ordination Centre. When accidents occur, survivors may be either on the surface or entrapped in a submarine resting on the seabed. Generally, medical care requirements for survivors of an underwater or submarine accident is specialized and competent medical advice is required.
- Vessels believing they have collided with a submarine, as with a collision with any vessel, should anticipate a requirement to provide SAR assistance. Further information on Submarine SAR and its parallel activity, Submarine Escape and Rescue, may be found at the website maintained by the International Submarine Escape and Rescue Liaison Office.



Section 2 – Rendering Assistance

Contents

Initial Action by Assisting Craft

Vessels Assisting

Methods of Distress Notification.....	2-1
Immediate Action.....	2-1
Proceeding to the Area of Distress.....	2-5
On-Board Preparation.....	2-5
Life-saving and rescue equipment.....	2-5
Signalling equipment.....	2-6
Preparations for medical assistance.....	2-6
Miscellaneous equipment.....	2-6

<i>Vessels Not Assisting</i>	2-7
------------------------------------	-----

Aircraft Assisting

Distress Call and Message Received.....	2-7
Immediate Action.....	2-7
Proceeding to Area of Distress	
Navigation equipment.....	2-8
Communications equipment.....	2-8
Miscellaneous equipment.....	2-8

Search Function

Search Action Plan and Message.....	2-9
Developing Own Search Planning.....	2-10
Search Patterns.....	2-10
On-Scene Radiocommunications.....	2-11
Visual Communications.....	2-11
Look-outs.....	2-15
Day.....	2-15
Night.....	2-16

Rescue Function

Rescue Action Plan and Message 2-16
 Developing a Rescue Plan..... 2-17

Assistance by SAR Aircraft

 Supply Dropping 2-18
 Assistance by Helicopters 2-19
 Rescue Sling 2-20
 Double Lift Method 2-20
 Rescue Basket 2-21
 Rescue Net 2-21
 Rescue Litter 2-21
 Rescue Seat 2-22
 Hi-Line Technique 2-22

Helicopter Operations

 General 2-23
 Communications between Ship and Helicopter
 for Winching Operations 2-24
 Helicopter to Ship 2-24
 Ship to Helicopter 2-25
 Sample Briefing to Vessel Prior to
 Helicopter Winching 2-26
 Vessel Preparation 2-27
 Positioning of Landing or Pick-up Areas 2-27
 Safety Preparations 2-29
 Safety Precautions when Approaching or Leaving
 a Helicopter 2-33

Rescue by Maritime Facilities

 General Maritime Considerations 2-33
 Ocean incident 2-35
 Coastal incident 2-35

Assistance to Ditching Aircraft	2-35
Recovery of Survivors by Assisting Vessels.....	2-36
Rescue by Land Facilities	2-37
Care of Survivors	
Immediate Care of Survivors.....	2-38
Recording Information on Survivors.....	2-38
Debriefing of Survivors	2-39
Handling of Deceased Persons	2-40
Contact with the Media	2-41
Other Assistance	
Intercept and Escort Service	
General.....	2-43
Aircraft Intercepts	2-44
Direct Intercepts.....	2-44
The head-on direct intercept	2-44
The overtaking direct intercept.....	2-46
The offset or beam-on intercept.....	2-47
Minimum Time to Scene Intercept (MTTSI).....	2-50
Aircraft Ditching	
Aircraft Ditching Guidance.....	2-52
Surface Craft Assistance.....	2-52
Communications	
Radio.....	2-52
Visual	2-53
Prefix call sign.....	2-53
Assistance from Ships	2-53
Rescue and Care of Survivors	2-55

Training

Search and Rescue Personnel 2-56

Air Search and Rescue Facilities..... 2-56

 Pilots 2-56

 Navigators 2-57

 Observers 2-57

 Supply Droppers 2-57

Maritime Search and Rescue Facilities

 Crew Members 2-58

 Deck Officers 2-58

 Radio Operators..... 2-59

 Look-outs 2-59

 Crews of Rescue Boats 2-60

 First Aid 2-60

Land Search and Rescue Facilities..... 2-60

Pararescue and Paramedical Personnel 2-62

Depot Personnel..... 2-63

Masters and Officers of Merchant Ships..... 2-63

Section 2 – Rendering Assistance

Initial Action by Assisting Craft

Vessels Assisting

■ *Methods of Distress Notification*

- An alarm signal or a distress call from another vessel at sea, either directly or by relay.
- A distress call or message from aircraft. This usually occurs by relay from a CRS.
- Alert sent from a vessel's alerting equipment and then relayed shore-to-ship.
- Visual signals or sound signals from a nearby distressed craft.

■ *Immediate Action*

- The following immediate action should be taken by any ship receiving a distress message:
 - acknowledge receipt of message.
 - gather the following information from the craft in distress if possible:
 - position of distressed craft
 - distressed craft's identity, call sign, and name
 - number of POBs
 - nature of the distress or casualty
 - type of assistance required
 - number of victims, if any
 - distressed craft's course and speed
 - type of craft, and cargo carried
 - any other pertinent information that might facilitate the rescue

Section 2 – Rendering Assistance

- maintain a continuous watch on the following international frequencies, if equipped to do so:
 - 500 kHz (radiotelegraphy)
 - 2182 kHz (radiotelephony)
 - 156.8 MHz FM (Channel 16, radiotelephony) for vessel distress
 - 121.5 MHz AM (radiotelephony) for aircraft distress
- after 1 February 1999, vessels subject to the SOLAS Convention must comply with applicable equipment carriage and monitoring requirements
- SOLAS communications equipment is referred to as Global Maritime Distress and Safety System (GMDSS) equipment, and includes:
 - Inmarsat ship earth stations
 - VHF, MF, and HF digital selective calling (DSC) radios
 - maritime safety information receivers like NAVTEX and SafetyNET
 - hand-held VHF equipment
 - emergency position-indicating radio beacons (EPIRBs)
 - search and rescue radar transponders (SARTs)
- any vessel carrying GMDSS-compatible equipment should use it as intended, and must be prepared at all times to receive distress alerts with it (see figures on pages 2-3 and 2-4).
- Vessels should maintain communications with the distressed craft while attempting to advise the SAR system of the situation.
- The following information should be communicated to the distressed craft:
 - own vessel's identity, call sign, and name
 - own vessel's position
 - own vessel's speed and estimated time of arrival (ETA) to distressed craft site
 - distressed craft's true bearing and distance from ship.
- Use all available means to remain aware of the location of distressed craft (such as radar plotting, chart plots, Global Positioning System (GPS)).

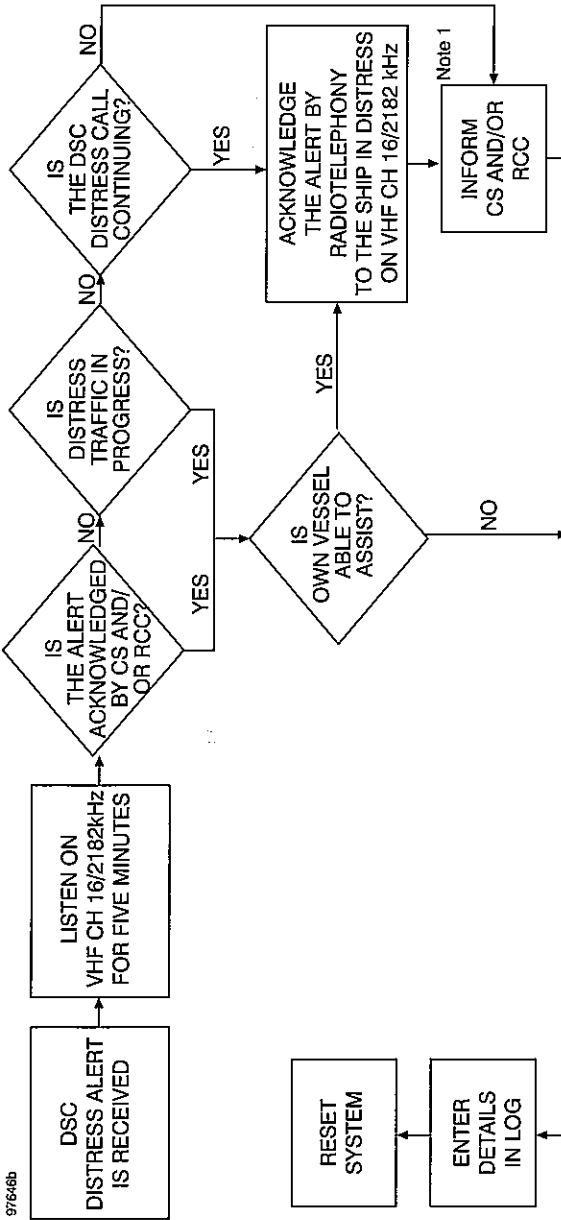

Remarks:

Note 1: Appropriate or relevant RCC and/or Coast Station shall be informed accordingly. If further DSC alerts are received from the same source and the ship in distress is beyond doubt in the vicinity, a DSC acknowledgement may, after consultation with an RCC or Coast Station, be sent to terminate the call.

Note 2: In no case is a ship permitted to transmit a DSC distress relay call on receipt of a DSC distress alert on either VHF channel 70 or MF channel 2187.5 kHz.

CS = Coast Station RCC = Rescue Co-ordination Centre

Actions by ships upon reception of VHF/MF DSC distress alert

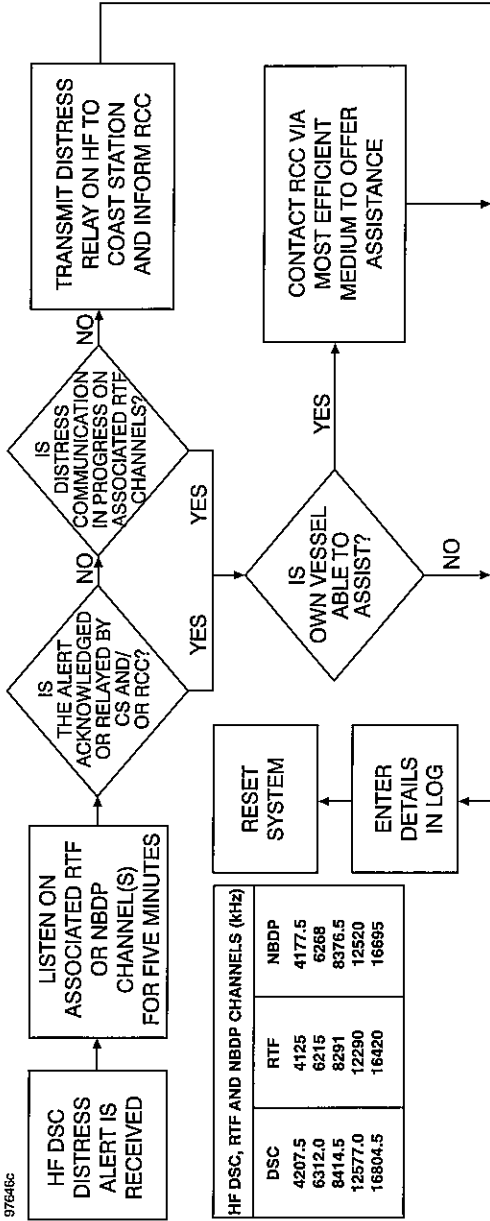

Remarks:

- Note 1: If it is clear the ship or persons in distress are not in the vicinity and/or other crafts are better placed to assist, superfluous communications which could interfere with search and rescue activities are to be avoided. Details should be recorded in the appropriate log-book.
- Note 2: The ship should establish communications with the station controlling the distress as directed and render such assistance as required and appropriate.
- Note 3: Distress relay calls should be initiated manually.

CS = Coast Station RCC = Rescue Co-ordination Centre

Actions by ships upon reception of HF DSC distress alert

- When in close proximity, post extra look-outs to keep distressed craft in sight.
- The ship or CRS co-ordinating distress traffic should establish contact with the SMC and pass on all available information, updating as necessary.

■ ***Proceeding to the Area of Distress***

- Establish a traffic co-ordinating system among vessels proceeding to the same area of distress.
- Maintain active radar plots on vessels in the general vicinity.
- Estimate the ETAs to the distress site of other assisting vessels.
- Assess the distress situation to prepare for operations on-scene.

■ ***On-Board Preparation***

- A vessel *en route* to assist a distressed craft should have the following equipment ready for possible use:

Life-saving and rescue equipment:

- lifeboat
- inflatable liferaft
- lifejackets
- survival suits for the crew
- lifebuoys
- breeches buoys
- portable VHF radios for communication with the ship and boats deployed
- line-throwing apparatus
- buoyant lifelines
- hauling lines
- non-sparking boat hooks or grappling hooks
- hatchets
- rescue baskets
- litters
- pilot ladders
- scrambling nets
- copies of the *International Code of Signals*

Section 2 – Rendering Assistance

- radio equipment operating on MF/HF and/or VHF/UHF and capable of communicating with the SMC and rescue facilities, and with a facility for direction finding (DF)
- supplies and survival equipment, as required
- fire-fighting equipment
- portable ejector pumps
- binoculars
- cameras
- bailers and oars.

Signalling equipment:

- signalling lamps
- searchlights
- torches
- flare pistol with colour-coded signal flares
- buoyant VHF/UHF marker beacons
- floating lights
- smoke generators
- flame and smoke floats
- dye markers;
- loud hailers.

Preparations for medical assistance, including:

- stretchers
- blankets
- medical supplies and medicines
- clothing
- food
- shelter.

Miscellaneous equipment:

- If fitted, a gantry crane for hoisting on each side of ship with a cargo net for recovery of survivors.
- Line running from bow to stern at the water's edge on both sides for boats and craft to secure alongside.
- On the lowest weather deck, pilot ladders and manropes to assist survivors boarding the vessel.
- Vessel's lifeboats ready for use as a boarding station.

- Line-throwing apparatus ready for making connection with either ship in distress or survival craft.
- Floodlights set in appropriate locations, if recovery at night.

Vessels Not Assisting

The master deciding not to proceed to the scene of a distress due to sailing time involved and in the knowledge that a rescue operation is under way should:

- Make an appropriate entry in the ships's log-book.
- If the master had previously acknowledged and responded to the alert, report the decision not to proceed to the SAR service concerned.
- Consider reports unnecessary if no contact has been made with the SAR service.
- Reconsider the decision not to proceed nor report to the SAR service when vessel in distress is far from land or in an area where density of shipping is low.

Aircraft Assisting

■ *Distress Call and Message Received*

- Aircraft may receive a distress call or message from craft directly or by relay via an ATS unit.
- Aircraft over the sea may receive an alarm signal or a distress call from a vessel. This usually occurs by relay from a CRS.
- Aircraft may receive a distress signal aurally from an EPIRB or ELT on 121.5 MHz.
- Aircraft near a distressed craft may receive visual signals.

■ *Immediate Action*

- Reports should be evaluated to determine their validity and degree of urgency.
- Any aeronautical station or aircraft knowing of an emergency incident should relay the MAYDAY or transmit a distress message whenever such action is necessary to obtain assistance for the person, aircraft, or vessel in distress.
- In such circumstances, it should be made clear that the aircraft transmitting the message is not itself the distressed craft.

■ **Proceeding to Area of Distress**

- In proceeding to an area of distress, prepare to assist the distressed craft.
- Categories to consider include:

Navigation equipment

- aircraft designated for SAR operations should be equipped to receive and home in on:
 - radio signals
 - emergency locator transmitters (ELTs)
 - EPIRBs
 - SARTs
- precise navigation equipment such as GPS can be helpful in covering a search area carefully or locating a datum.

Communications equipment

- all aircraft should be equipped to maintain good communications with the SMC and other aeronautical SAR facilities
- designated SAR aircraft engaged in sea rescues should be equipped to communicate with vessels or survival craft
- designated SAR aircraft should be able to communicate with survivors on VHF-FM on Channel 16 (156.8 MHz) and VHF-AM on 121.5 MHz
- carriage of droppable disposable radios operating on 123.1 MHz can be used for communications with survivors
- carriage of portable radios may be appropriate for aircraft SAR facilities to communicate with maritime or land SAR facilities and OSCs.

Miscellaneous equipment

- the following equipment, as appropriate, should be readily available for SAR operations:
 - binoculars
 - a copy of the *International Code of Signals*
 - signalling equipment, such as pyrotechnics
 - buoyant VHF/UHF marker beacons, floating lights
 - fire-fighting equipment
 - cameras for photographing wreckage and location of survivors
 - first-aid supplies

- loud hailers
- containers for dropping written messages
- inflatable liferafts
- lifejackets and lifebuoys
- portable hand-held battery-powered droppable radio for communicating with survivors
- any equipment which may assist with rescue operations.

Search Function

■ **Search Action Plan and Message**

- The SMC typically provides the search action plan.
- The OSC and facilities on-scene implement the search action plan (see example message in appendix B).
- Search action plan message includes six parts.

Situation

- a brief description of the incident
- position of the incident, and time that it occurred
- number of persons on-board (POBs)
- primary and secondary search objects
- amount and types of survival equipment
- weather forecast and period of forecast
- SAR facilities on-scene

Search area(s) (presented in column format)

- area designation, size, corner points, centre point, and circle radius
- other essential data

Execution (presented in column format)

- SAR facility identification, parent agency, search pattern, creep direction, commence search points, and altitude

Co-ordination required

- designates the SMC and OSC
- SAR facility on-scene times
- desired track spacing and coverage factors
- OSC instructions (e.g., use of datum marker buoys)

Section 2 – Rendering Assistance

- airspace reservations (e.g., danger area)
- aircraft safety instructions
- SAR facility change of operational co-ordination (SAR facility follows co-ordinating guidance of SMC or OSC)
- parent agency relief instructions
- authorizations for non-SAR aircraft in the area

Communications

- co-ordinating channels
- on-scene channels
- monitor channels
- method for OSC to be identified by SAR facilities
- press channels, if appropriate

Reports

- OSC reports of on-scene weather, progress, and other SITREP information, using standard SITREP format
 - parent agencies to provide summary at the end of daily operations, (hours flown, area(s) searched, and coverage factor(s)).
- The OSC may be authorized by the SMC to alter the search action plan based on on-scene considerations.

■ ***Developing Own Search Planning***

- Considerations in developing a search plan include:
 - estimating the most probable position of a distressed craft or survivors, taking drift effect into consideration
 - determining the search area
 - selecting SAR facilities and equipment to be used
 - selecting a search pattern
 - planning on-scene co-ordination.
- Section 3 provides specific search planning guidance.

■ ***Search Patterns***

- Factors to consider in deciding what type of search pattern to use include:
 - available number and types of assisting craft
 - size of area to be searched
 - type of distressed craft

- size of distressed craft
 - meteorological visibility
 - cloud ceiling
 - type of sea conditions
 - time of day
 - arrival time at datum.
- Section 3 provides specific information on search patterns.







■ **On-Scene Radiocommunications**

- The OSC should co-ordinate communications on-scene and ensure that reliable communications are maintained.
 - SAR facilities normally report to the OSC on an assigned frequency
 - if a frequency shift is carried out, instructions should be provided about what to do if intended communications cannot be re-established on the new frequency
 - all SAR facilities should carry a copy of the *International Code of Signals*, which contains communications information for use with aircraft, vessels, and survivors
 - normally, the SMC will select SAR-dedicated frequencies for use on-scene, which will include primary and secondary frequencies.









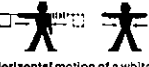

■ **Visual Communications**

- The following visual means of communication should be used when appropriate:
 - signalling lamp
 - international code flags
 - international distress signals.
- The following tables describe the life-saving signals referred to in regulation V/29 of SOLAS 1974, as amended, and are intended for use by:
 - SAR facilities engaged in SAR operations when communicating with ships or persons in distress
 - ships or persons in distress when communicating with SAR facilities.

Section 2 - Rendering Assistance

	MANUAL SIGNALS	LIGHT SIGNALS	OTHER SIGNALS	MEANING
Day signals	 Vertical motion of a white flag or of the arms	 or firing of a green star signal	 or code letter K given by light or sound-signal apparatus	This is the best place to land
Night signals	 Vertical motion of a white light or flare	 or firing of a green star signal	 or code letter K given by light or sound-signal apparatus	

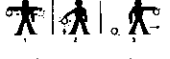





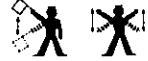

A range (indication of direction) may be given by placing a steady white light or flare at a lower level and in line with the observer.

Day signals	 Horizontal motion of a white flag or of the arms extended horizontally	 or firing of a red star signal	 or code letter S given by light or sound-signal apparatus	Landing here highly dangerous
Night signals	 Horizontal motion of a light or flare	 or firing of a red star signal	 or code letter S given by light or sound-signal apparatus	
Day signals	 1 Horizontal motion of a white flag, followed by 2 the placing of the white flag in the ground and 3 by the carrying of another white flag in the direction to be indicated	 1 or firing of a red star signal vertically and 2 a white star signal in the direction towards the better landing place	1 or signalling the code letter S (. .) followed by the code letter R (. .) if a better landing place for the craft in distress is located more to the right in the direction of approach 2 or signalling the code letter S (. .) followed by the code letter L (. .) if a better landing place for the craft in distress is located more to the left in the direction of approach	Landing here highly dangerous. A more favourable location for landing is in the direction indicated
Night signals	 1 Horizontal motion of a white light, or flare 2 followed by the placing of the white light or flare on the ground and 3 the carrying of another white light or flare in the direction to be indicated	 1 or firing of a red star signal vertically and 2 a white star signal in the direction towards the better landing place	1 or signalling the code letter S (. .) followed by the code letter R (. .) if a better landing place for the craft in distress is located more to the right in the direction of approach 2 or signalling the code letter S (. .) followed by the code letter L (. .) if a better landing place for the craft in distress is located more to the left in the direction of approach	



57647

Landing signals for the guidance of small boats with crews or persons in distress

Section 2 - Rendering Assistance

	MANUAL SIGNALS	LIGHT SIGNALS	OTHER SIGNALS	MEANING
Day signals	 Vertical motion of a white flag or of the arms	 or firing of a green star signal		In general: affirmative Specifically: rocket line is hoist - tall block is made fast - hewer is made fast - man is in the breeches buoy - haul away
Night signals	 Vertical motion of a white light or flare	 or firing of a green star signal		
Day signals	 Horizontal motion of a white flag or of the arms extended horizontally	 or firing of a red star signal		In general: negative Specifically: slack away - haul
Night signals	 Horizontal motion of a white light or flare	 or firing of a red star signal		

Signals to be employed in connection with the use of shore life-saving apparatus

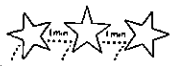
Day signals	 Orange smoke signal	 or combined light and sound signal (thunder-light) consisting of 3 single signals which are fired at intervals of approximately one minute	You are seen - assistance will be given as soon as possible (Repetition of such signal shall have the same meaning)
Night signals	 White star rocket consisting of 3 single signals which are fired at intervals of approximately one minute		

If necessary, the day signals may be given at night or the night signals by day.

Replies from life-saving stations or maritime rescue units to distress signals made by a ship or person





5724

Section 2 – Rendering Assistance

Signals used by aircraft engaged in search and rescue operations to direct ships towards an aircraft, ship or person in distress

PROCEDURES PERFORMED IN SEQUENCE BY AN AIRCRAFT





MEANING

 <p>1 CIRCLE the vessel at least once.</p>	 <p>2 CROSS the vessel's projected course close AHEAD at a low altitude while ROCKING the wings. (See Note).</p>	 <p>3 HEAD in the direction in which the vessel is to be directed.</p>	<p>The aircraft is directing a vessel towards an aircraft or vessel in distress.</p> <p>(Repetition of such signals shall have the same meaning)</p>
<p>CROSS the vessel's wake close ASTERN at low altitude while ROCKING the wings. (See Note)</p>  <p>NOTE Opening and closing the throttle or changing the propeller pitch may also be practiced as an alternative means of attracting attention to that of rocking the wings. However, this form of sound signal may be less effective than the visual signal of rocking the wings owing to high noise level on board the vessel.</p>			<p>The assistance of the vessel is no longer required.</p> <p>(Repetition of such signals shall have the same meaning)</p>

Air-to-surface visual signals

Signals used by a vessel in response to an aircraft engaged in search and rescue operations

MEANING

 <p>Hoist "Code and Answering" pendant Close up; or</p>	 <p>Change the heading to the required direction; or</p>	 <p>Flash Morse Code signal "T" by signal lamp.</p>	<p>Acknowledges receipt of aircraft's signal</p>
 <p>Hoist International flag "N" (NOVEMBER); or</p>		 <p>Flash Morse Code signal "N" by signal lamp.</p>	<p>Indicates inability to comply</p>







Use the following surface-to-air visual signals by displaying the appropriate signal on the deck or on the ground.

Message	ICAO-IMO visual signals
Require assistance	V
Require medical assistance	X
No or negative	N
Yes or affirmative	Y
Proceeding in this direction	↑

Surface-to-air visual signals

Reply from an aircraft observing the above signals from surface craft or survivors.



MEANING

				Use any other suitable signal	Message understood
Drop a message or	Rock the wings (during daylight) or	Flash the landing lights or navigation lights on and off twice (during hours of darkness) or	Flash Morse Code signal "T" or "R" by light or		
		Use any other suitable signal			Message not understood (repeat)
Fly straight and level without rocking wings or	Flash Morse Code signal "RPT" by light or				Message not understood (repeat)

Air-to-surface visual signals



Procedures performed by an aircraft.

MEANING

		The aircraft wishes to inform or instruct survivors
Drop a message or	Drop communication equipment suitable for establishing direct contact	

Signals by survivors in response to a message dropped by an aircraft

MEANING

	use any other suitable signal	Dropped message is understood by the survivors
Flash Morse Code signal "T" or "R" by light or		
	Dropped message is not understood by the survivors	
Flash Morse Code signal "RPT" by light		

97650

* High visibility coloured streamer

Signals by survivors

■ Look-outs

- Look-outs, also referred to as observers or scanners, are very important for effective searches. Their location on the search facility, scanning technique, and concentration on searching should be of concern to the search facility. They should report any object or noise.
- Aircraft observers must concentrate visual scans within the distance of the track spacing.
- Vessels:

Day

- Place look-outs high on the vessel.

Night

- Place look-outs on the bows as far forward and as low to the water's edge as possible to hear any calls for help and to establish the best night vision.
- Factors Affecting Observer Effectiveness (appendix C) provides advice for all look-outs. Factors include:
 - weather conditions and visibility
 - type of search craft (vessel, aircraft, liferaft, or person)
 - state of the sea (calm, choppy, or rough)
 - land features (woods, desert, jungle)
 - daytime or night-time
 - look-out fatigue.

Rescue Function

Rescue Action Plan and Message

- A rescue action plan is normally prepared by the SMC for implementation by the OSC and facilities on-scene, and may be provided to them in a rescue action message.
- Potential parts of the message, similar to those for a search action message, are as noted below.

Situation

- includes a brief description of:
 - incident
 - number of persons requiring rescue
 - extent of injuries
 - amount and type of survival equipment
 - weather forecast and period for forecast
 - SAR facilities on-scene

Rescue area

- describes the position of the incident
- gives access routes to be followed by SAR facilities

Execution

- lists SAR facilities assigned, including facility call sign and parent agencies providing them
- rescue method to be attempted
- lists supplies or equipment to be delivered

Co-ordination

- designates the SMC and OSC
- on-scene time for SAR facilities
- change of operational co-ordination (SAR facility follows co-ordinating directions of SMC or OSC)
- parent agency relief instructions
- temporary flight restrictions
- authorization for non-SAR aircraft in the area

Communications

- prescribes co-ordination and on-scene channels
- call signs of aircraft assigned high-altitude communications relay duties
- other relevant communications information.

Reports

- discusses required OSC to SMC reports
- parent activity reports.

■ ***Developing a Rescue Plan***

- Although the SMC normally prepares a rescue plan, sometimes the OSC may have to develop it.
- Factors to consider include:
 - risk to SAR personnel
 - number, location and disposition of the survivors
 - condition of survivors and medical considerations
 - current meteorological conditions
 - current sea conditions, as appropriate
 - time of day
 - survival equipment on hand
 - type of rescue craft, etc.

- In a distress incident, even uninjured persons who are supposedly able-bodied and capable of logical thought are often unable to accomplish simple tasks and may hinder their own rescue.

Assistance by SAR Aircraft

■ *Supply Dropping*

- Assistance by aircraft during a SAR mission can include dropping liferafts and equipment to craft in distress, lowering trained individuals from helicopters, or evacuating survivors by helicopter.
- Ships in distress or survivors may be supplied by SAR aircraft with special items of droppable equipment.
- Suggested procedure for aerial delivery of rafts, supplies, and equipment to persons in watercraft or in water:
 - approach slightly upward and perpendicular to the wind direction
 - drop item(s) with 200 m buoyant trail line attached to a position 100 m ahead of survivors
 - let trail line fall so that it will float downwind to survivors.
- The contents of each container or package should:
 - be clearly indicated in print, in English and one or more other languages
 - have self-explanatory symbols
 - have streamers coloured according to the following code:
 - **Red** – medical supplies and first-aid equipment
 - **Blue** – food and water
 - **Yellow** – blankets and protective clothing
 - **Black** – miscellaneous equipment such as stoves, axes, compasses, cooking utensils, etc.
- Miscellaneous equipment includes:
 - individual liferafts
 - liferafts linked by a buoyant rope
 - buoyant radio beacons and transceivers
 - dye and smoke markers and flame floats
 - parachute flares for illumination
 - salvage pumps.

- The following factors should be considered when deciding whether or not supplies should be dropped:
 - communications with the survivors
 - supplies needed by survivors
 - availability of suitable aircraft and trained crew.
- Success of an air drop is affected by:
 - correct release point
 - drift effect of the wind
 - speed and height of the aircraft
 - relative locations of the distress site and the rescue facility's base
 - time before rescue can be effected
 - danger of exposure.

■ **Assistance by Helicopters**

- A helicopter may be used to supply equipment and rescue or evacuate persons.
- The radius of helicopter action usually varies up to 300 nautical miles from base, but it can be greater, especially with air-to-air refuelling.
- Lifting capacity is between one and up to 30 persons depending on the size and type of aircraft.
- Rescue operations involve helicopter crew risks which should be minimized.
 - it is essential to evaluate the seriousness of the situation, and to ascertain the need of helicopter assistance.
- The helicopter's mass may be a factor limiting the number of survivors taken aboard each trip.
 - it may be necessary to reduce the mass of the helicopter by removal of non-essential equipment, or using minimum fuel loads and advance bases with fuelling capabilities.
- For the evacuation of persons, the end of a winching cable may be provided with a rescue sling, basket, net, litter, or seat.
- Experience has shown that when winching a person suffering from hypothermia, especially after immersion in water, a rescue basket or stretcher should be used to keep the person in a horizontal position, since winching in a vertical position may cause severe shock or cardiac arrest.

Rescue Sling

- The most widely used means for evacuating persons is the rescue sling.
- Slings are suited for quickly picking up uninjured persons, but are unsuitable for persons with injuries.
- The sling is put on in much the same way as one puts on a coat, ensuring that the loop of the sling passes behind the back and under both armpits.
- The person using the sling must face the hook. Hands should be clasped in front as shown.
- The person must not sit in the sling, nor should the sling be unhooked.

Double Lift Method

- Some SAR helicopters use the double lift method which consists of a normal sling and a seating belt manned by a helicopter crew member.
- This method is suitable for pick-up of incapacitated persons from land, water, or the deck of a vessel, if they are not injured badly enough so that a litter has to be used.
- The helicopter crew member puts the person into the sling and conducts the winching operation

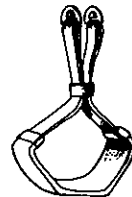
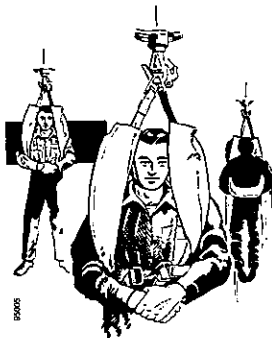

Rescue sling

Rescue Basket

- Use of the rescue basket does not require any special measures. To use the basket, the person merely climbs in, remains seated and holds on.

Rescue Net

- The rescue net has a conical “bird cage” appearance and is open on one side.
- To use the net the person merely enters the opening, sits in the net, and holds on.

Rescue Litter

- Patients will in most cases be disembarked by means of a rescue litter.
- The evacuation of patients can be done in a special litter provided by the helicopter or in a litter provided at the site.
- Bridles are fitted to this litter and can quickly and safely be hooked on and off.
- The litter provided by the helicopter should be unhooked from the winch cable while the patient is being loaded.

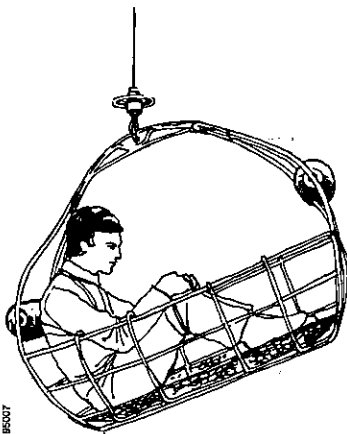

Rescue basket

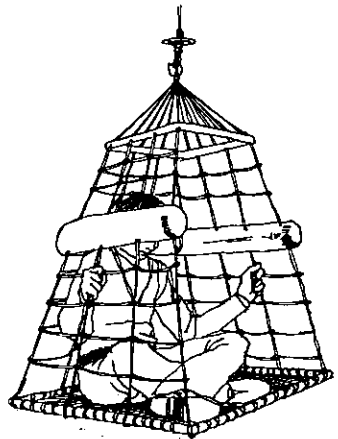

Rescue net

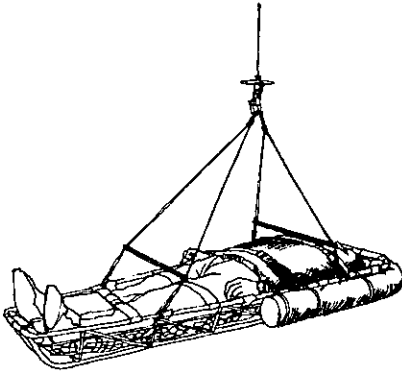

Rescue litter



Rescue seat

Rescue Seat

- The rescue seat looks like a three-pronged anchor with two flat flukes or seats.
- Persons to be hoisted merely sit astride on one or two of the seats and wrap their arms around the shank.
- This device can be used to winch two persons at once.

Hi-Line Technique

In certain circumstances, typically, poor weather, obstructed vision or confined winching area, it may not be possible to lower the helicopter crewman or lifting harness to the deck from directly above the vessel. In such cases the Hi-Line technique may be used.

- A weighted line, attached to the aircraft's hook by a weak link, is lowered to the vessel. It may be illuminated by cyaline lightsticks. The transfer area should give unobstructed access to the deck edge.
- The line should be handled by one member of the vessel's crew.
- **ONLY WHEN INSTRUCTED BY THE HELICOPTER CREW** the slack should be hauled in (it is advisable to wear gloves).
- **THE LINE MUST NOT BE MADE FAST.**

- The helicopter will pay out the line and descend to one side of the vessel while the crewman continues to take in the slack. A second crewmember should coil the spare line into a container, clear of obstructions.
- When the helicopter crewman or lifting harness reaches deck height the line must be hauled in to bring the winch hook on board (considerable effort may be required).
- The static discharge line must touch the vessel before contact with the hook is made.
- At any time the helicopter may discontinue the operation, in which case the line must be paid out immediately, clear of obstructions.
- When prepared for winching the helicopter crewman, if present, or a member of the vessel's crew, should indicate to the helicopter by hand signals.
- The helicopter will climb and winch in the cable. The line must be paid out maintaining sufficient force to prevent a swing.

If multiple transfers are required to be made the line should be retained. On the final lift the end of the line should be released over the side of the vessel.

Helicopter Operations

■ General

- Helicopter operations include landing and winching on land or at sea. Landings on vessels will normally be done on well-equipped and trained craft. Discussion here will focus on winching since it may be conducted for various trained and untrained facilities. Winching can be hazardous to the persons being hoisted, the rescue facility, and others at the scene of the winching.
- The final decision about whether it is safe to conduct the winching, subject to agreement of personnel at the scene, is with the person in command of the rescue facility.

Section 2 – Rendering Assistance

- The vessel or the ground facility at the rescue scene should be briefed on what is required. A sample briefing is provided after this discussion. This briefing can be given by another SAR facility prior to the on-scene arrival of the helicopter.

■ *Communications between Ship and Helicopter for Winching Operations*

- It is important that information be exchanged between the vessel and helicopter, and that it is understood.
- A direct radio link should be established between ship and helicopter. This is usually accomplished by having the helicopter equipped with a marine VHF FM radio able to transmit and receive on at least Channel 16 and preferably on two other simplex working frequencies.
- The exchange of information and instructions about rendezvous positions, etc., may be established through shore-based radio stations.
- Unless other arrangements have been agreed upon in advance, the ship should monitor VHF Channel 16 for the arrival of the helicopter.
- When the helicopter is equipped for DF, it can identify the ship and home on it by using the ship's radio transmission on an agreed frequency.
- To avoid any misunderstandings, the following is a selection of internationally developed phrases which may be used as appropriate.

Helicopter to Ship

- Join me on VHF Channel . . .
- Query – what is your exact position?
- Please transmit a long homing signal on 410 kHz.
- Query – what is your course?
- Query – what is your speed?
- Query – what is the present relative wind direction and speed across your deck?
- Query – what are the pitch, roll, sea, and spray conditions at the operating area?

- I understand that your vessel has
 - a landing area with a clear zone of _____ metres in diameter on the port/starboard side/centre line, or
 - a pick-up area with a manoeuvring zone of _____ metres in diameter on the port/starboard side. I propose to serve you on the port/starboard/centre line landing/pick-up area.
- I will be overhead your vessel in _____ minutes.
- I have you in sight.
- Query – is the ship ready?
- Query – is the deck party ready?
- Query – is the operating area clear of unnecessary personnel?
- Query – is the fire-fighting equipment ready?
- Please confirm that there are no obstructions above the operating area.
- Please confirm that all passengers have been briefed on winching procedures.
- Please confirm permission to land.
- I am standing by.
- I expect to be ready in _____ minutes.
- Please maintain your course and speed (if possible).
- Can you alter course to _____ degrees?
- Can you reduce speed to _____ knots?
- Please advise when you have steadied on your new speed/course.
- Can you resume your original course and speed?
- Acknowledgement.

Ship to Helicopter

- My vessel's position is _____ miles from _____ (prominent point).
- My vessel has
 - a landing area with a clear zone of _____ metres diameter on the port/starboard side/centre line, or
 - a pick-up area with a manoeuvring zone of _____ metres diameter on the port/starboard side.
- My vessel is/is not ready for you to approach.

- Stand by. I expect to be ready for you to approach in _____ minutes.
 - My present course is _____ degrees.
 - My present speed is _____ knots.
 - The relative wind is _____ degrees at _____ knots.
 - I am shipping light spray on deck/heavy spray on deck.
 - I am pitching/rolling moderately/heavily.
 - Query – do you wish me to alter course?
 - Query – do you wish me to reduce speed?
 - The ship is ready – all preparations have been made.
 - Affirmative: you have permission to proceed with the operation.
 - Affirmative: you have permission to land.
 - Acknowledgement.
- Means of communication between ship and helicopter are further indicated in the *International Code of Signals – General Section, DISTRESS – EMERGENCY* under “AIRCRAFT – HELICOPTER”.

■ **Sample Briefing to Vessel Prior to Helicopter Winching**
(Modify text for helicopter winching over land)

“A helicopter is proceeding to your position and should arrive at approximately _____. Maintain a radio watch on _____ MHz/kHz/Channel _____ VHF-FM. The helicopter will attempt to contact you. Provide a clear area for winching, preferably on the port stern. Lower all masts and booms that can be lowered. Secure all loose gear. Keep all unnecessary people clear of the pick-up area. Just before the helicopter arrives, secure the ship’s radar or put it in standby mode. Do not direct lights towards the helicopter as it will adversely affect the pilot’s vision. Direct available lighting to illuminate the pick-up area. When the helicopter arrives, change course to place the wind 30 degrees on the port bow and maintain a steady course and steerage-way. As the helicopter approaches, strong winds may be produced by the rotors, making it difficult to steer. The helicopter will provide all the equipment for the winching. A line will probably be trailed from the helicopter for your crew to guide the rescue device as it is lowered. Before touching the rescue device, allow it to touch your vessel. This will discharge static electricity. If you have to move the rescue device from the pick-up area to load the patient, unhook the cable from the

rescue device and lay the loose hook on the deck so it can be retrieved by the helicopter. Do not attach the loose hook or the cable to your vessel. The helicopter may move to the side while the patient is being loaded. Have the patient wear a lifejacket, and attach any important records, along with a record of medications that have been administered. When the patient is securely loaded, signal the helicopter to move into position and lower the hook. After allowing the hook to ground on the vessel, re-attach it to the rescue device. Signal the winch operator with a “thumbs up” when you are ready for the winching to begin. As the rescue device is being retrieved, tend the trail line to prevent the device from swinging. When you reach the end of the trail line, gently toss it over the side.”

■ **Vessel Preparation**

- The following information should be exchanged between the helicopter and the vessel:
 - position of the vessel
 - course and speed to the rendezvous position
 - local weather conditions
 - how to identify the vessel from the air (such as flags, orange smoke signals, spotlights, or daylight signalling lamps).
- Section 4 provides a checklist for the vessel’s use.

■ **Positioning of Landing or Pick-up Areas**

- Operating areas on vessels should be located on the main deck and, if practicable, arranged on both port and starboard sides.
 - the operating areas consist of an outer manoeuvring zone and an inner clear zone
 - whenever possible, the clear zone should be close to the ship’s side
 - any amount of the manoeuvring zone may extend outboard but none of the clear zone may do so.
- Identify clear access to the operating area and exit from it to the ship’s side.
- Establish the best position within the area for the manoeuvring zone that will give the largest clear zone.

Section 2 – Rendering Assistance

- Areas close to the bow are not recommended due to the increased air-flow turbulence created by the ship's passage.

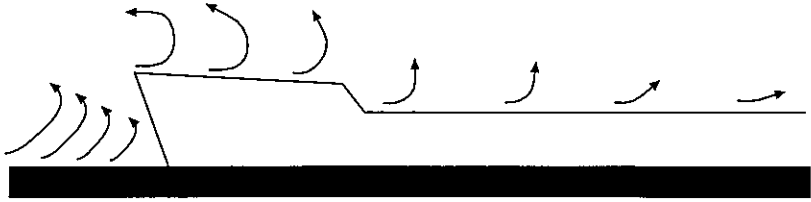

- As large a stretch of deck which is clear of obstructions should be made available as a pick-up area.
- Larger vessels may have areas marked on their decks. These markings are an aiming circle with "H" painted in white for landing, or a circle with an inner circle painted yellow for winching only, as shown below.

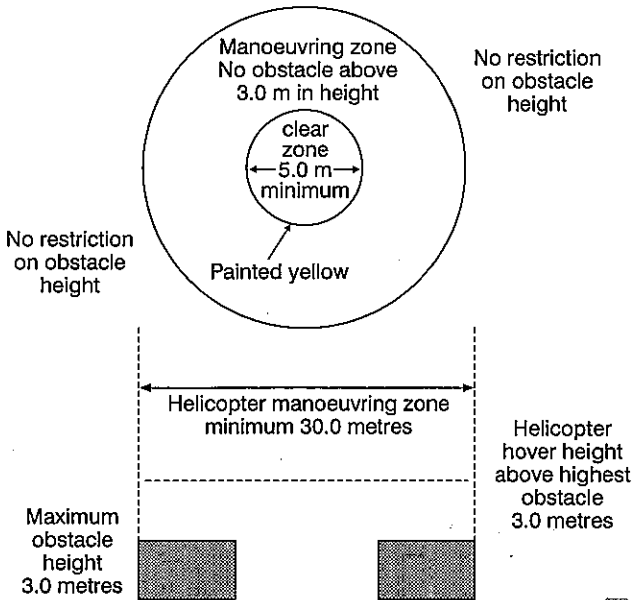

- During the night, pick-up area floodlighting should be provided and the floodlights should be located so as to avoid glare to pilots in flight or to personnel working on the area.
 - the arrangement and aiming of floodlights should be such that they are not directed towards the helicopter and shadows are kept to a minimum
 - the spectrum distribution of the floodlights should be such that the surface and obstacle markings can be correctly identified
 - obstacles should be clearly identified by obstacle lights
 - where pick-up area floodlighting and obstacle lighting cannot be provided, the ship should, in consultation with the pilot, be illuminated as brightly as possible, particularly the pick-up area and any obstructions, such as masts, funnels, deck gear, etc.
- Clothing or other objects lying about should be cleared away or secured due to strong air-wind current from the helicopter.
- The helicopter may be able to lift a person from a lifeboat or a liferaft secured on a long painter. However, liferafts have been overturned by the helicopter's air-current.

■ **Safety Preparations**

- A briefing to discuss the safety aspects and operational details of helicopter-ship operations should be held for all involved personnel prior to the operation's commencement.
- Wherever available, the following fire-fighting equipment or its equivalent should be ready during helicopter operations:
 - at least two dry powder extinguishers with an aggregate capacity of not less than 45 kg
 - a suitable foam application system (fixed or portable), capable of delivering a foam solution at a rate of not less than 6 litres per minute for each square metre of clear zone and sufficient foam compound to enable the rate to be maintained for at least five minutes
 - carbon dioxide (CO₂) extinguishers with an aggregate capacity of not less than 18 kg
 - a deck water system capable of delivering at least two jets of water to any part of the helicopter operating area

Section 2 – Rendering Assistance

- at least two fire hose nozzles which should be of the dual-purpose type
- fire-resistant blankets and gloves
- sufficient fire proximity suits
- portable fire-fighting equipment for oil fires should be stationed near the disembarkation space
- if possible, the fire-fighting pump should be started and hoses should be connected and kept in readiness.
- For better identification from the air, and also for showing the direction of the wind to the helicopter pilot, flags and pennants should be flown.
- All crew members concerned, as well as the persons to be evacuated, should wear lifejackets
 - this precaution may be amended when it would cause unjustifiable deterioration of the condition of the patient to be transferred.
- Care should be taken that the patient does not wear loose clothing or headgear.
- On no account should the lifting device on the end of the winch cable be secured to any part of the ship or become entangled in the rigging of fixtures.
- Ship's personnel should not attempt to grasp the lifting device unless requested to do so by the helicopter crew.
 - Even in this case, a metal part of the lifting device should first be allowed to touch the deck in order to avoid possible shock due to static electricity.
- When helicopter winching is to be done from carriers of flammable or explosive cargo, in the vicinity of a flammable mixture spillage, the winching must be grounded clear of spillage or the carrier's tank venting area in order to preclude a possible fire or explosion from an electrostatic discharge.
- The helicopter pilot will want to approach the ship in such a way that the helicopter will hover into the relative wind and with the pilot's side (starboard) closest to the ship during the approach.

Section 2 - Rendering Assistance

- If the helicopter is to approach in the usual manner, from the stern, the ship should maintain a constant speed through the water and keep the wind 30 degrees on the port bow or on either beam if the area is amidships, or 30 degrees on the starboard quarter if the area is forward.
- A flow of air, as free of turbulence as possible, clear of smoke and other visibility restrictions, over the pick-up area is very important
- These procedures may be modified on instructions from the pilot if communications exist.
- Personal belongings should not be taken along.
 - Loose gear can become entangled in the winch cable or pulled up into the helicopter rotors.

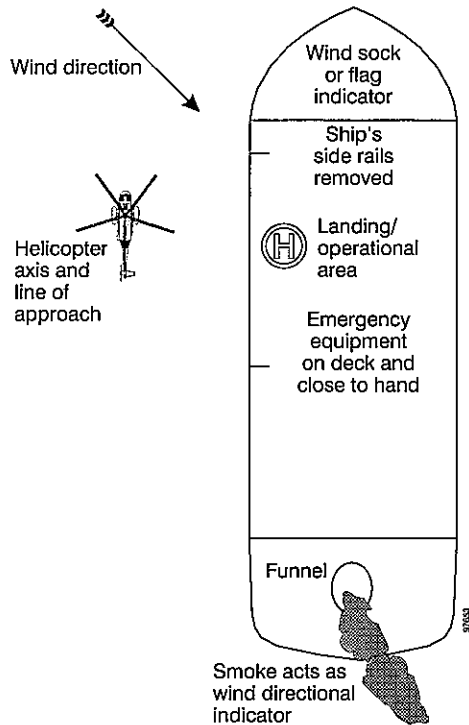

Section 2 – Rendering Assistance

- The following diagrams show the appropriate day shape a vessel must display while engaged in helicopter operations and signals that may be used in winching communications:



97654

FORWARD

Signal given to helicopter pilot to indicate that the vessel is ready and the helicopter may approach. (Arms repeatedly moved upward and backwards, beckoning onward.)

97655

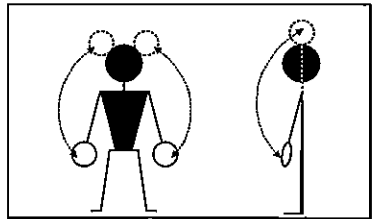

FINISHING OPERATIONS

Signal given to helicopter pilot to indicate operations finished. (Arms repeatedly crossed above the head.)

97656

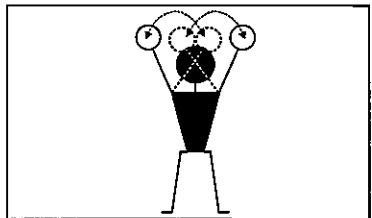

Helicopter operations

■ **Safety Precautions when Approaching or Leaving a Helicopter**

- Do not approach or depart a helicopter UNLESS directed to do so by the pilot or crewman

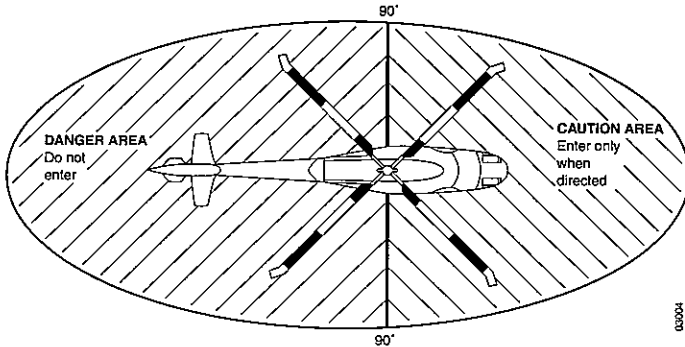

Generic safety illustration

■ **Rescue by Maritime Facilities**

■ **General Maritime Considerations**

- For survivors in the water, the rescuing vessel may find it necessary to:
 - rig scramble nets
 - launch lifeboats
 - launch liferafts
 - have crew members suitably equipped to enter the water to assist survivors
 - be prepared to provide initial medical treatment.
- For a fire or extremely heavy weather, or where it is impossible for the rescue ship to come alongside, then a lifeboat or liferaft may be towed to a closer position.
- In heavy weather, the use of oil for reducing the effect of the sea should be considered.
 - experience has shown that vegetable oils and animal oils, including fish oils, are most suitable for quelling waves

Section 2 - Rendering Assistance

- lubricating oils may be used
- fuel oil should **not** be used, except as a last resort, as it is harmful to persons in the water
- lubricating oil is less harmful, and tests have shown that 200 litres discharged slowly through a rubber hose with an outlet just above the sea, while the ship proceeds at slow speed, can effectively quell a sea area of some 5,000 square metres
- in heavy weather, a ship with a low freeboard may be better suited to effect rescue.
- A boarding station may be rigged by mooring a liferaft alongside.
 - it is particularly useful when lifeboats are used
 - survivors can be quickly unloaded into the boarding station, releasing the boat for another trip.
- The direction of approach to the distressed craft (or survivors) will depend upon circumstances.
 - some emergencies, such as a ship on fire, may have to be approached from windward and
 - others, such as liferafts, from leeward.
 - the two key factors are:
 - whether a lee-side protection is necessary during the rescue operation and
 - the comparative rates of drift of the distressed craft and the rescuing ship.
- If time permits, assess the relative rates of drift.
 - this precaution may prevent serious mishaps during the rescue operations
 - in general, survivors in the water are best approached from the leeward side.
- If practicable, arrange for injured personnel requiring the attention of a medical officer to be transferred to a ship carrying one.

Ocean incident

- if there is no ship available with a medical officer on board, the rescue facility should request the OSC, if assigned, or the SMC to consider transmitting an urgency message requesting such a ship to a rendezvous
- if necessary, a CRS may be contacted for ship reporting systems information on the availability of ships with a medical officer.

Coastal incident

- the SMC should arrange for medical assistance to be sent from shore
- the local CRS may act as an intermediary.

■ Assistance to Ditching Aircraft

- Aircraft usually sink quickly, within minutes. Vessels will often be the rescue facility.
- When an aircraft decides to ditch in the vicinity of a ship, the ship should:
 - transmit homing bearings to the aircraft
 - transmit signals enabling the aircraft to take its own bearings
 - by day, make black smoke
 - by night, direct a searchlight vertically and turn on all deck lights (care must be taken NOT to direct a searchlight towards the aircraft which may adversely affect the pilot's vision).
- A ship which knows that an aircraft intends to ditch should prepare to give the pilot the following information:
 - wind direction and force,
 - direction, height, and length of primary and secondary swell systems,
 - current state of the sea,
 - current state of the weather.
- The pilot of an aircraft will choose his own ditching heading.
- If this is known by the ship, it should set course parallel to the ditching heading.

Section 2 - Rendering Assistance

- Otherwise, the ship should set course parallel to the main swell system and into the wind component as shown in the figure below:

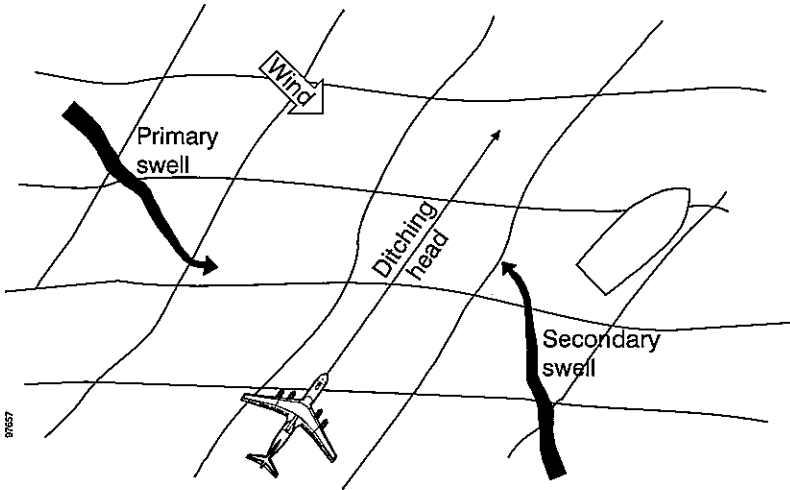

■ **Recovery of survivors by assisting vessels**

- Seafarers should consider how to recover survivors into their own vessels under various environmental conditions. Recovery methods include:
 - Using throwing rockets or heaving lines to pass lifebuoys and/or lines to survivors;
 - Streaming a rope, with lifebuoys or other flotation attached;
 - Rigging pilot ladders, jacob's ladders or nets, preferably clear of the ship's side, with safety lines. If survivors are unable to climb, ladders or nets may have to be recovered with the survivors secured to them. Where practicable:
 - rig ladders or nets from pilot doors or other low openings,
 - deploy safety lines with rescue strops or loops,
 - use suitably equipped crew members to assist survivors directly,
 - deploy a liferaft with the ladder or net to act as a transfer platform;
 - Pulling survivors up suitable marine evacuation systems;

- Deploying liferafts or lifeboats for survivors to hold onto, or climb into;
- Using rafts or boats as lifts, leaving them on the falls if conditions permit;
- Lifting survivors using gantries, cranes, davits or derricks, with lines rigged to minimize swinging against the ship's side;
- Deploying purpose-built or improvised recovery baskets;
- Rigging a boat rope for boats and survival craft to secure alongside;
- Lowering embarkation ladders.
- Any lights in use must not be directed towards helicopters operating in the area.
- Survivors in the water should be lifted in a horizontal or near-horizontal position if possible (for example, in two strops; one under the arms, the other under the knees) to minimize the risk of shock induced by sudden transfer from the water and possible hypothermia.
- Assisting vessels should also be prepared to receive survivors from helicopters: see page 2-23.
- When the risks involved in recovery operations outweigh the risks of leaving the survivors in life-saving appliances, consider the following actions:
 - Using the ship to provide a lee for the survivors;
 - Deploying life-saving appliances from the assisting vessel;
 - Maintaining visual and communications contact with the survivors;
 - Updating the co-ordinating authority;
 - Transferring essential survival and medical supplies.

Rescue by Land Facilities

- The duties of a land facility at a distress scene include:
 - giving initial medical treatment
 - collecting and preserving medical and technical data for investigatory purposes
 - making a preliminary examination of the wreckage
 - reporting to the SMC, and
 - evacuating survivors by whatever means are available.

Section 2 - Rendering Assistance

- Aircraft crash sites have special requirements
 - for military aircraft, extreme care should be taken to avoid hazardous materials or triggering the ejection seat (the activating handles are normally coloured red or yellow-and-black)
 - do not disturb aircraft wreckage except to assist in recovery of survivors
 - except for compelling reasons, bodies or human remains should not be moved without authorization from the SMC.

Care of Survivors

■ *Immediate Care of Survivors*

- Once on board, medical care and welfare of the survivors should be attended to. Additional assistance should be sought from the SAR authorities as required.
- Medical advice should be sought from the Telemedical Maritime Advice Service, via the RCC.
- After a rescue, survivors may require hospital treatment.
- They must be delivered to a place of safety as quickly as possible.
- The SMC should be advised if ambulances are needed.
- SAR personnel should be alert and ensure that after rescue, survivors are not to be left alone, particularly if injured or showing signs of physical or mental exhaustion.
- When survivors are delivered to a hospital, the person in charge of the delivering facility should provide information on all initial medical treatment given to the survivors.

■ *Recording Information on Survivors*

- Survivor information should include:
 - type of injury suffered by the patient
 - describe serious injury
 - describe secondary injuries
 - how the injury occurred
 - the history of the most serious injury may give valuable insight into the nature and extent of injuries which may not be noticed otherwise

- past medical history
 - includes previous surgery
 - congenital defects
 - illnesses, allergies
 - medication taken
- results of a full secondary assessment, including
 - vital signs
 - other signs
 - symptoms
- treatment given
 - particularly morphine and similar narcotic drugs
 - amounts and times administered
- times when tourniquets, splints, or compress bandages were applied
- for stretcher cases, this information should be noted and placed in a waterproof pouch, and securely attached to the survivor
- medical records pertaining to the survivor should be delivered to the hospital as soon as possible.

■ **Debriefing of Survivors**

- Survivors should be questioned about the distressed craft as soon as possible. Their input may be able to further assist in the SAR operation, future SAR operations, or the prevention of incidents in the future. The information should be relayed to the SMC.
- Questions to ask include the following:
 - What was the time and date of the incident?
 - Did you bail out or was the aircraft ditched?
 - If you bailed out, at what altitude?
 - How many others did you see leave the aircraft by parachute?
 - How many ditched with the aircraft?
 - How many did you see leave the aircraft after ditching?
 - How many survivors did you see in the water?
 - What flotation gear had they?
 - What was the total number of persons aboard the aircraft prior to the accident?
 - What caused the emergency?
 - What was the total number of persons on board the vessel?

Section 2 - Rendering Assistance

- What was the last known position?
- Were any of the persons able to leave by lifeboat or raft?
- How long was the survivor in the water?
- Were search craft seen before the survivors were located and, if so, what were the dates and times of the sightings?
- Were any signals or devices used to try to attract the attention of search craft? If so, what were they and when were they used?
- Survivors should also be questioned about their medical history:
 - recurring disease
 - heart trouble
 - diabetes
 - epilepsy
 - conditions from which they may suffer.
- This information should be noted, together with any medical attention given, for future attending physicians.
- Questioning survivors has many purposes.
 - to ensure that all survivors are rescued
 - to attend to the physical welfare of each survivor
 - to obtain information which may assist and improve SAR services.
- Care must be taken to avoid worsening a survivor's condition by excessive interrogation.
- If the survivor is frightened or excited, the questioner should assess these statements carefully.

Note: Questions should be asked in a calm voice and the questioner should avoid suggesting answers to the survivor. Explain that the information required is for the success of the SAR operation and may be of great value for future SAR operations.

Handling of Deceased Persons

- Searching for and recovering bodies is not normally considered to be part of SAR operations. However, handling of human remains may at times be necessary.
- Human remains at an aircraft crash site should not be disturbed or removed without authorization from the SMC except for compelling reasons.

- Without exposing rescuers to danger, an attempt should be made to identify deceased persons. All articles removed from or found near each body must be kept separate, preferably in a container so labelled that it can be correlated later with the body. All these articles should be handed over to the proper authority as soon as possible.
- When human remains are recovered during a SAR operation, or when a death occurs on board a SAR facility, a waybill should be made out for each deceased person. It should contain the full name and age of the deceased (if known), as well as the place, date, time, and cause of death (if possible). This waybill should be made out in the national language of the SAR facility and, wherever possible, in English.
- Considerations for the transport of human remains include:
 - on vessels, body bags or sailcloth for human remains should be carried (If human remains are kept on board for any length of time, they should be properly wrapped and put in a suitable place on the vessel.)
 - SAR aircraft do not normally transport human remains (However, SAR aircraft may have to carry human remains if no other means are readily available.)
 - immediately after return to a base specified by the RCC, the remains must be handed over to the appropriate authorities, accompanied by the waybill
 - if it is known or suspected that a deceased person had an infectious disease, all material and objects which have been in direct contact with the deceased person must be cleaned and disinfected or destroyed.

Contact with the Media

- A SAR operation often creates great interest with relatives of the victims, the general public, and with radio, television, and newspapers. Contacts with the media are normally the responsibility of the RCC or higher authority.
- The media may be waiting when the rescue facility returns to its base or reaches its next destination, and may sometimes arrange to conduct interviews over radio links. In such situations where there will be contact with the media, a rescue facility spokesperson should be designated. That person should exercise good judgement and avoid:

Section 2 – Rendering Assistance

- personal judgements or demeaning information on the:
 - crew or missing persons
 - judgement, experience, or training of the pilot-in-command, captain, or the crew
 - degrading opinions on the conduct of the SAR operations (only factual information should be given)
 - personal opinions or theories as to why the accident occurred or how it could have been avoided
 - giving names of missing or distressed persons until every effort has been made to inform the relatives
 - giving the name of the operator or the owner of the aircraft, ship, or other craft before they have been informed
 - revealing names of persons who have given information related to the case.
- The rescue facility spokesperson should refer any request for personal opinions, comments on departmental policies, search rationale or sensitive matters to the appropriate RCC and/or higher authority.
 - On the other hand, the type of information that the RCC spokesman could release, depending on the specific circumstances of the SAR operation, includes, but is not limited to:
 - general reason for the SAR operation;
 - type of aircraft or vessel involved;
 - owner/operator of the aircraft or vessel (only after the owner/operator has been informed and given consent);
 - name of vessel/flight number (only after the owner/operator has been informed and given consent);
 - number of people on board;
 - general area being searched;
 - number and types of aircraft and vessels engaged in the search and the number of hours flown;
 - arrangements for land or marine search (as applicable);
 - details of other authorities participating in the search;
 - contact number for use by the next of kin to obtain information;
 - contact number for further information; and
 - contact number for media enquiries;

Other Assistance

- SAR facilities may be required to perform operations other than search and rescue, which if not carried out could result in a SAR incident.
 - Assist a craft that is in a serious or potentially serious situation and in danger of becoming a SAR incident, such as a:
 - collision at sea
 - loss of propulsion
 - fire
 - grounding
 - vessel taking on water
 - insufficient remaining fuel.
 - Provide medical assistance.
 - Alert appropriate authorities of unlawful acts being committed against an aircraft or vessel:
 - pirate attack
 - hijacking attempt.
 - Assist after the vessel or aircraft has been abandoned, to minimize future hazards.

Intercept and Escort Service

■ *General*

- The purpose of this service is to minimize delay in reaching the scene of distress and to eliminate a lengthy search for survivors. Escort service for both aircraft and vessels will normally be provided to the nearest adequate aerodrome or nearest safe haven.
- Intercept procedures apply to both vessels and aircraft. However, the higher rate of speed of aircraft often requires a more rapid calculation of the intercept course and speed.
- The following assistance can be provided by an escort:
 - provide moral support to the persons on board the distressed craft
 - assume the navigation and communication functions of the distressed craft, thereby permitting its crew to concentrate on coping with the emergency
 - visually inspecting the exterior of the distressed craft

Section 2 – Rendering Assistance

- advise on procedures for:
 - ditching an aircraft
 - abandoning a vessel
 - beaching a vessel
 - provide illumination during:
 - aircraft ditching
 - vessel abandonment
 - assist in the approach procedure at the destination
 - provision of emergency and survival equipment, carried by the escort facility
 - direct rescue facilities to the distress scene.
- The SMC may alert SAR facilities capable of providing an escort facility and dispatch an escort facility when appropriate.

Aircraft Intercepts

- When visual contact has been made, the intercepting aircraft will normally take up a position slightly above, behind and to the left of the distressed craft.

■ Direct Intercepts

- Three types of direct intercept are possible. They are the head-on, overtaking, and offset or beam-on intercepts. For direct intercepts, it is usually assumed that the SAR facility's speed is greater than that of the distressed craft.
- A distressed aircraft should not be asked to change its heading for a direct intercept unless the aircraft:
 - is lost
 - requires minor heading changes to correct for navigation error
 - is in imminent danger and cannot reach safety.

The head-on direct intercept solution:

- plot the simultaneous position of SAR and distressed aircraft
- the SAR aircraft flies a reciprocal track to that being flown by the distressed aircraft
- compute the distance between the simultaneous position plots and the rate of closure
- divide the distance separating the two aircraft by rate of closure to determine the time of interception

Or (graphical solution):

- plot the relative positions of both the distressed craft (A) and the intercepting SAR facility (B) for that time at which the intercepting SAR facility is ready to proceed
- join the two positions with a line (AB)
- lay off a line at 90° to the distressed craft's course made good and project it a reasonable distance (AC)
- along this line, measure off the distance it will cover in one hour, based on the speed it is making good, and mark the position with an X
- lay off a line at 90° to the intercepting SAR facility's course made good on the opposite side of AB and project it a reasonable distance (BD)
- along this line, measure off the distance the intercepting SAR facility will cover in one hour, based on the speed it can make good along its intended course, and mark the position with a Y
- join the positions X and Y with a line. Where it cuts the course line is the intercept position, P
- to find the time for this intercept, measure the distance from the initial position of either craft to the position of intercept and divide this distance by the speed of the chosen craft.

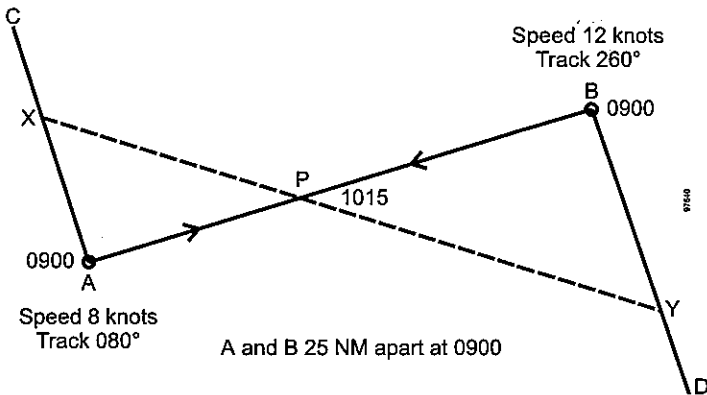

Head-on method

The overtaking direct intercept solution:

- plot the simultaneous position of SAR facility and distressed craft
- the SAR facility moves along the same track to that of the distressed craft
- compute the distance between the simultaneous position plots and the rate of closure
- divide the distance separating the two craft by rate of closure to determine the time of interception

Or (graphical solution):

- plot the relative positions of both the distressed craft (A) and the intercepting craft (B) for that time at which the intercepting SAR facility is ready to proceed
- join the two positions with a line and project it a reasonable distance (BC). This line is the course made good of both craft
- lay off a line at 90° to the intercepting SAR facility's course and project it a reasonable distance (BD)
- along this line, measure off the distance the intercepting SAR facility will cover in one hour, based on the speed it can make good along its intended course, and mark the position with an X
- lay off a line at 90° to the distressed craft's course and project it a reasonable distance (AE) on the same side as BD
- along this line, measure off the distance the distressed craft will cover in one hour, based on the speed it is making good, and mark the position with a Y
- join the positions X and Y with a line and project it until it cuts the course line at F. This is the intercept position
- to find the time for the intercept, measure the distance from the initial position of either craft to the position of the intercept, and divide this distance by the speed of the chosen craft.

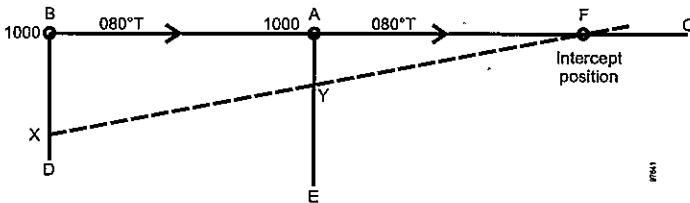

Overtaking method

The offset or beam-on intercept:

- The offset or beam-on intercept is used when the SAR facility is to one side of the track being made good by the distressed craft.
- The SAR facility intercepts the track of the distressed aircraft.
- When the distressed craft has the greater ground speed, the SAR facility will have to be closest to the point of intended landing to make the offset interception possible. There are three methods for performing offset or beam-on intercepts.

Method 1:

- plot the relative positions of both the distressed craft (A) and the intercepting SAR facility (B) for that time at which the intercepting SAR facility is ready to proceed
- join these two positions with a line (AB)
- lay off the distressed craft's track in the direction of its heading and project it a reasonable distance on the chart (AC)
- along this projected track or course line of the distressed craft, measure off the distance it will cover in one hour, based on its speed through the air (TAS for aircraft) or water (vessels), and mark the position with an X
- transfer the line joining the two craft through the plotted position, X (XY)
- with the centre of the circle being the point of departure of the intercepting SAR facility, and using a radius equal to the distance it will cover in the time interval used for the distressed craft, describe an arc and mark the spot (W) where the arc cuts the transferred line

Note: If the speed of the intercepted or intercepting vessel is such that the scale of the chart makes it unreasonable to use a full hour, then it will be necessary to use a proportional interval of time to ensure that the radius of the arc cuts the transferred line.

- draw a line from the position of the intercepting SAR facility through the spot where the arc cuts the transferred line – this is the intercept heading/course for the intercepting SAR facility. By projecting this line until it cuts the projected track or course line of the distressed craft, one finds the position where the intercept will take place (D)

Section 2 – Rendering Assistance

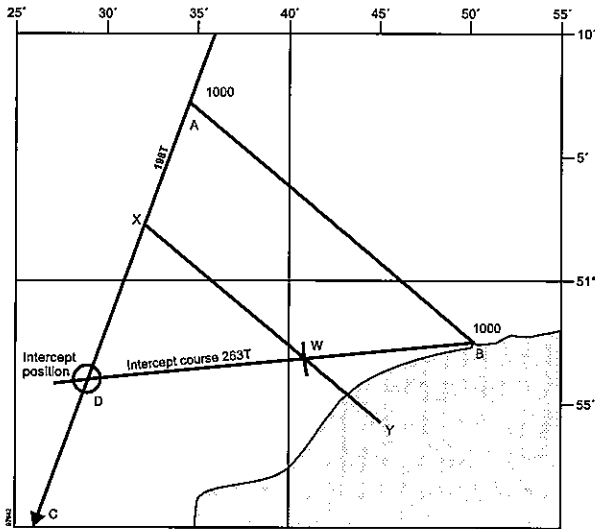

Offset or beam-on intercept: method 1

- to find the time it will take for the intercept, measure the distance from the initial position of the intercepting vessel to the point of intercept and divide this distance (BD) by the speed of the intercepting vessel.

Method 2 (with wind/current effects):

- plot the simultaneous positions of the distressed aircraft (A) and the SAR aircraft (B)
- a ten-minute lead to the position of the distressed aircraft is allowed for navigational errors (C) and the position of the distressed aircraft one hour later (D) is plotted
- plot these dead-reckoning (DR) positions based on speed in knots and course made good over the ground
- a line of constant bearing (LCB) is drawn between positions B and C
- a second LCB, parallel to BC, is drawn through point D
- a wind vector (BF), drawn downwind from the original position of the SAR aircraft, is drawn
- an arc equal to the SAR aircraft TAS is swung through the second LCB, using the end of the wind vector (F) as the centre of origin

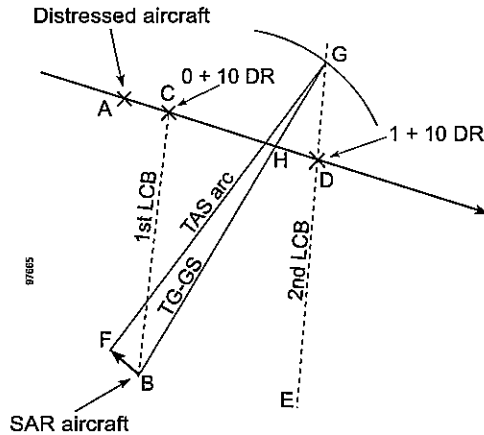

Offset or beam-on intercept: method 2

- the bearing and distance of the line drawn from the original position of the SAR aircraft (B) to point (G) represent interception true course and ground speed. If necessary, this line is extended until it crosses the projected true course of the distressed aircraft (H)
- the distance to intercept the intended track of the distressed aircraft is measured between the original position of the SAR aircraft (B) and the point at which the interception true course crosses the projected true course of the distressed aircraft (H)
- the *en-route* time for this distance and closure time for the lead distance are computed and added to determine total time required for collision point intercept with the distressed aircraft
- depending on the speed differential, the SAR aircraft may execute a turn to the reciprocal of the track of the distressed aircraft when the course of the distressed aircraft has been intercepted
- interception of the course of the distressed aircraft can be confirmed by DF from the distressed aircraft.

Method 3 (using direction-finding equipment):

- This procedure requires that the SAR aircraft have DF equipment that can receive transmission from the distressed aircraft, and is

Section 2 – Rendering Assistance

executed as shown in the following figure, using magnetic bearings.

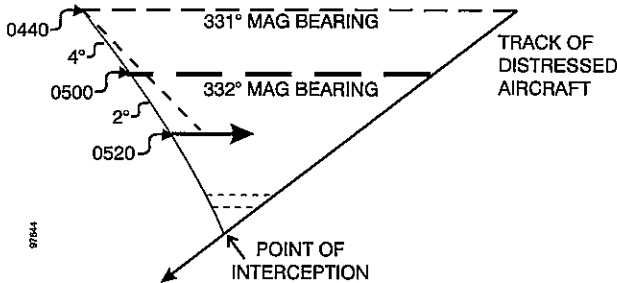

Offset or beam-on intercept: method 3

- determine the bearing to the distressed aircraft, turn the SAR aircraft to a heading 45° from this bearing in the direction the distressed aircraft is flying
- maintain a relative bearing of 45° by checking DF bearings
- if the DF check reveals that the bearing from the SAR aircraft has increased, the interception course should be increased twice the amount of the change between the last two bearings
- if the check reveals that the bearing from the SAR aircraft has decreased, the interception course should be decreased twice the amount of change between the last two bearings
- by bracketing the bearings as described above, an interception course is determined, maintaining a line of constant bearing.

■ *Minimum Time to Scene Intercept (MTSI)*

- This procedure was developed to intercept and escort higher-speed aircraft with lower-speed aircraft SRUs.
 - because of speed differential, it may be necessary for the SRU aircraft to turn short of the interception point on the distressed aircraft track to minimize the time-to-scene (provide maximum rescue availability) over the remaining distance to be flown
 - compute the SRU's maximum operating distance
 - compute the time to launch the SRU

- compute the time at which the SRU should turn around (time-to-turn or TTT) and allow the distressed aircraft to begin overtaking it
- when the SRU reaches the turn-around point, its time-to-scene from there to the distressed aircraft's position should equal the SRU's remaining time to the destination at the time the distressed aircraft lands
- keep the distressed aircraft informed of the type and the status of the interception being performed.
- The MTTSI should be used when all of the following conditions exist:
 - the distressed aircraft is not, nor expected to be, in immediate danger of ditching, crash landing, or bailout before it reaches the SRU's maximum operating distance
 - the SRU will depart and return to the same aerodrome that is the distressed aircraft's destination
 - the SRU's true air speed is less than that of the distressed aircraft
 - the position of the distressed aircraft is accurately known.
- The SRU's maximum operating distance is computed as follows:
 - subtract the required fuel reserve time and the estimated time required on-scene from the SRU's maximum endurance to get the maximum operational endurance
 - the SRU's maximum operating distance is found by using the formula:

$$D_{mo} = \frac{T_{mo} V_{a1} V_{a2}}{V_{a1} + V_{a2}}$$

where:

D_{mo} = maximum operating distance

T_{mo} = maximum operational endurance

V_{a1} = ground speed of SRU aircraft, outbound to intercept

V_{a2} = ground speed of SRU aircraft, inbound after TTT

- for distressed aircraft beyond the SRU's maximum operating distance, the SRU's launch time is computed using the following formula:

$$T_0 = 60 \left[\frac{D}{V_b} - D_{mo} \frac{V_{a1}^2 + 2V_{a1}V_{a2} + V_{a2}V_b}{V_{a1}V_b(V_{a1} + V_{a2})} \right]$$

where:

T_0 = time to launch, in minutes, after the emergency was declared

Section 2 – Rendering Assistance

D = distance, in NM, of the distressed aircraft from the aerodrome when the emergency was declared

V_b = ground speed of the distressed aircraft in knots

Note: If the computed value of T_0 is negative, the SRU may be launched immediately.

- the time to turn, in minutes after SRU launch, is computed using the following formula:

$$T_{a1} = \frac{60D_0V_{a2}(V_{a1} + V_b)}{V_b(V_{a1}^2 + 2V_{a1}V_{a2} + V_{a2}V_b)}$$

where:

T_{a1} = time to turn, in minutes, after the SRU's launch time

D_0 = distance, in NM, of the distressed aircraft from the aerodrome when the SRU is launched.

Aircraft Ditching

■ Aircraft Ditching Guidance

- Aircraft emergency procedures for ditching are provided in section 4.

■ Surface Craft Assistance

- If an aircraft has to ditch, or the crew bail out over water, the most advantageous place is near a surface craft, preferably alongside and slightly ahead. Further discussion is provided within the maritime portion of this section.

■ Communications

Radio

- The different maritime and aeronautical radio bands make direct communications between vessel (especially merchant vessel) and aircraft difficult.
- Most civil aircraft flying over ocean areas are equipped with VHF/AM radios (118–136 MHz) and HF/SSB radios (3–20 MHz). Military aircraft normally have UHF radios (225–399.9 MHz) and HF/SSB radios (3–30 MHz).
- Both military and civil aircraft maintain contact with ATS units on HF while over ocean areas.
- In emergencies, the pilot normally advises an ATS unit of the situation and intentions.

- If not able to continue toward an aerodrome, the pilot usually asks the ATS unit to advise of any ships in the area and ask them to establish a voice watch on 4125 kHz to assist in ditching and rescue.
- Merchant ships are ordinarily informed of aircraft distress situations by broadcast messages from CRSs on the international distress frequencies of 500 kHz, 2182 kHz, or 156.8 MHz (VHF channel 16).
- Few aircraft can operate on these frequencies.
- Emergency communications are usually established with aircraft on 4125 kHz or 5680 kHz.
- Communication between an aircraft and a vessel often may have to be relayed via a SAR aircraft, military vessel, or ground station.

Visual

- While there is no standard emergency signal to indicate ditching, an aircraft in distress can use any means to attract attention, make its position known, and obtain help.
- Lowering landing gear and flashing landing lights on and off may be used to signal ditching intentions.

Prefix call sign

During search and rescue missions and exercises it is recommended that the following prefix call signs be used before the ordinary radio call sign or as a specific mission call sign:

“RESCUE” for all airborne units involved in a rescue mission

“AIR CO-ORDINATOR” for the aircraft co-ordinator (ACO)

“SAREX” for all airborne units involved in international/national exercises.

■ Assistance from Ships

- Assistance that might be provided in a ditching situation includes:
 - establishing and maintaining communications with the aircraft
 - every effort should be made to establish direct voice communication between the ship and distressed aircraft
 - a lost-contact procedure should be arranged in the event that contact is lost

Section 2 – Rendering Assistance

- locating the aircraft. The ship may locate the aircraft by:

Radar

- standard procedure is for the distressed aircraft to put its transponder on Code 7700 (Useful for appropriately equipped vessels.)
- if this is not possible, the pilot may be able to make a 90° identification turn
- the pilot should hold the new course for three minutes and then return to base course

Homing signals

- if the ship can send homing signals on a frequency compatible with the aircraft's automatic direction finder, the pilot may be able to provide a reciprocal bearing

Shore-based assistance

- authorities may be able to provide a position on the aircraft from DF stations or other available information

Aircraft's navigational data

- the pilot may be able to give a position from navigational data

Weather data

- Unusual weather conditions reported by the pilot may give clues about the aircraft's position.

- Vectoring or assisting in homing the aircraft to the ship.
 - a ship may assist an aircraft by providing a homing signal or course to steer based on radar or DF bearings from the ship
 - during daylight, a ship may make black smoke, cruise at high speeds to form a wake, or use other means to attract attention visually
 - at night, star shells, searchlights, pyrotechnics, deck lights, or water lights may be used.
- Providing weather, sea information, and recommended ditching heading.
- Final determination of the ditching heading is the responsibility of the pilot, who should inform the ship of the selected ditching heading as soon as possible.

- Marking the sea lane along the selected ditching heading.
 - during daylight, with relatively calm sea conditions, a ship may mark the sea lane with fire-extinguisher foam
 - at night, or during a low-visibility daytime ditching, a ship may lay a series of floating lights along the selected ditching heading.
- Providing approach assistance.
 - approach may be made visually, by DF using the homing signals from the ship, by radar assistance from the ship, or by a combination of these
 - the ship will normally be to one side of the sea lane
 - under visual conditions, day or night, the aircraft should make a visual approach
 - during low ceiling or poor visibility, a ship may provide continuous homing signals through the final approach
 - it may also operate air navigation aids to allow an instrument approach
 - the pilot should be aware of the height of the masts on the ship and must allow some deviation on final approach in order not to collide with the ship
 - if the pilot desires, and radar contact is held by the ship, it may give radar ranges
 - full radar-controlled approach should not be attempted unless the ship is qualified in such approaches.
- Providing illumination.
 - ships with flare or star-shell capability can provide illumination at night for a visual approach
 - illumination may be placed over the ditching location and overshoot area, approximately 1200 metres (3600 feet) past the end of the sea lane
 - the ship may also fire an orientation flare when the pilot begins the approach.

Rescue and Care of Survivors

- Rescue may be by small boats or the ship itself.
- Survivors in the water or aircraft should usually be rescued first and those safe in rafts last.
- If there are serious injuries, the SMC can make medical arrangements.

Training

Search and Rescue Personnel

- Training of search and rescue personnel can include:
 - study of the application of SAR procedures, techniques, and equipment through lectures, practical demonstrations, films, SAR manuals, and journals
 - assisting in or observing actual operations
 - exercises in which personnel are trained to co-ordinate individual techniques and procedures in a simulated operation.

Air Search and Rescue Facilities

- In addition to normal flying programmes, each crew member should be given specialized experience in SAR techniques for that member's particular function and the type of aircraft.
- All crew members assigned to SAR duties should be familiar with the following:
 - air-surface co-ordination in SAR operations
 - signal codes and signalling methods used by surface craft and survivors
 - scanning and spotting techniques
 - action to be taken when sighting a distress scene
 - first aid.

■ *Pilots*

- Pilot training programmes should be aimed at developing one or more of the following techniques as appropriate to the type of operation involved:
 - precision in flying search patterns, maintaining tracks and height
 - flying at low levels as applicable to normal searches or to contour searches
 - dropping of supplies (selection of approach heading and height, judgement of release point)
 - intercepting and escorting aircraft
 - assistance to ditching aircraft
 - landing and take-off from confined areas
 - winching by helicopters.

■ **Navigators**

- Accurate navigation and continued knowledge of position within narrow limits is required, often in areas with no or few navigation aids.

■ **Observers**

- The observer (or look-out) performs a very important function and should preferably have aircrew experience; an untrained observer seriously reduces the efficiency of an air search.
- In addition to continued flight experience, personnel with observer duties should be given training on the following:
 - sufficient flying time for:
 - aircraft familiarization
 - familiarity with the terrain of likely search areas
 - knowledge of day and night scanning procedures
 - acquiring the ability to detect objects from the air under monotonous conditions for prolonged periods of time
 - knowledge of the appearance from the air of:
 - aircraft wreckage and associated marks (e.g., slash marks in standing timber, burnt-out areas, skid marks, or scattered pieces of wreckage.)
 - liferaft, lifeboat, dye marker trails, a person in the water
 - knowledge of supply dropping procedures.
- If extensive flying training is not practicable, the use of films, photographs and information circulars describing general procedures for observers may prepare observers for their task.
- Appendix C discusses factors affecting observer effectiveness.

■ **Supply Droppers**

- Personnel responsible for the dropping of supplies from aircraft should be familiar with:
 - stowage and handling of supply containers and parachutes
 - safety precautions during dropping operations
 - dropping techniques.

Maritime Search and Rescue Facilities

■ *Crew Members*

- Every opportunity should be taken to supplement training with SAR exercises as follows:
 - co-ordinated air–surface SAR operations
 - provision of assistance to aircraft (homing, communication, ditching)
 - knowledge of signalling methods and codes
 - handling of all types of survival craft and equipment
 - storage and maintenance of special equipment
 - removal of survivors from ships, other craft survival craft, and the sea
 - first aid, artificial respiration, general care of survivors and the injured
 - fire-fighting methods and associated equipment.

■ *Deck Officers*

- Training of deck officers should include all training required for crew members plus:

Organization

- knowledge of the SAR organization
- knowledge of available SAR facilities, including those of adjacent SRRs
- knowledge of legal aspects, particularly as regards to towing and salvage, etc.

Procedures

- search patterns and techniques for air and surface facilities
- communication procedures
- rescue procedures
- supply dropping procedures
- ditching assistance, stand-by and escort procedures
- debriefing of survivors

Seamanship

- navigation in difficult conditions close inshore or at sea and in close proximity to disabled vessels
- use and understanding of all electronic navigational equipment used on SAR craft, including their accuracy and limitations
- proper use of radar
- knowledge of charts, sailing directions, buoys, lights, and aids to navigation in the SRR
- use of publications on tides and currents relating to the SRR and the calculations of tidal conditions, as applicable
- use of weather and wave charts, pilot charts
- estimating the drift of survival craft
- methods of calculating the point of interception
- methods of recovery of survivors both close inshore and in the open sea from all kinds of craft in adverse weather conditions
- good seamanship
- methods of calculating search patterns.

■ **Radio Operators**

- All radio operators must be qualified in accordance with Article 55 of the ITU Radio Regulations for operating the specific equipment with which individual SAR craft are fitted.
- Additional training should include:
 - SAR communications procedures and regional communications plans
 - knowledge of communications facilities existing within the SRR and adjacent SRRs
 - an understanding of the practical difficulties which may be associated with ship-aircraft communications and possible methods of overcoming these conditions
 - knowledge of procedures for exchange of information with SAR surface craft and with the shore
 - knowledge of available operating frequencies for the SRR.

■ **Look-outs**

- Keeping a good look-out is a most important function, given the limited range of vision from surface craft and difficulty in locating objects and persons in the sea.

- Masters, commanding officers, and watch standing officers must be trained in properly briefing look-outs in their duties and the harmful effects of fatigue on the look-out.
- Training should include:
 - knowledge of distress signals
 - scanning methods and reporting sightings
 - signs of sunken ship or aircraft; for example, oil slicks or wreckage
 - relative range of detection for various types of search objects.
- Appendix C discusses factors affecting observer (look-out) effectiveness.

■ **Crews of Rescue Boats**

- Rescue boat crews should be trained in all duties that they could be called upon to perform.

■ **First Aid**

- Training in first aid should consist of formal instruction, demonstration, and exercises, given by qualified emergency medical personnel.
- Appropriate training aids should be used and copies of a first aid manual should be issued. The syllabus should include:
 - use of immersible litters and other devices for removing survivors from water
 - fundamental first aid, with emphasis on revival of the partially drowned and treatment for shock, prolonged immersion, hypothermia, and burns
 - artificial respiration (mouth to mouth, using a breathing tube)
 - administration of oxygen.

Land Search and Rescue Facilities

- Land facilities are normally established from groups whose members have special qualifications for operating in the type of terrain prevalent in their area.
- Additional training may be needed (such as search techniques, first aid, and radio communication procedures.)

- When staffed by volunteers whose only qualification is physical fitness, then training should be provided on:
 - familiarity with the terrain in which operations will be conducted and SAR methods and techniques to be employed
 - map reading and the use of a magnetic compass
 - ability to operate by day and night in all weather conditions with little outside help
 - knowledge of supply-dropping techniques
 - preparation of airstrips or clearings for helicopters
 - air-surface co-ordination in SAR operations
 - knowledge of fire prevention and fire-fighting methods in aircraft and aircraft wrecks
 - knowledge of signalling methods and codes
 - operation and maintenance of special equipment
 - evacuation of survivors and injured
 - first aid and general care of survivors.
- Land rescue personnel should be specially instructed concerning the removal of survivors and human remains from crashed aircraft.
 - knowledge of the position in the wreckage of both survivors and bodies may be of vital importance to the accident investigation
 - rescue personnel should be taught to make every effort to preserve such evidence to the maximum extent possible (such as photography)
 - rescue personnel should remove bodies only for a compelling reason, such as fire, or on the explicit instructions of the SMC or OSC or of a member of the accident investigation team.
- Training in medical aspects should consist of formal instruction, demonstrations and exercises, given and supervised by a competent instructor, e.g., a doctor or qualified emergency medical personnel. Manuals on initial medical assistance should be issued to the trainees. Training should include fundamental first aid and general care of survivors, including treatment for exposure. It should be stressed that medical advice should be obtained before the evacuation of seriously injured survivors.

Pararescue and Paramedical Personnel

- In addition to training in parachute-jumping techniques and procedures, pararescue and paramedical personnel should also be trained as members of a land facility.
- Pararescue and paramedical units should be able to make precision landings with minimum dispersal of the group and without injuring themselves or damaging or losing equipment. They should develop skills in:
 - accurate estimation of exit points from various altitudes
 - execution of jumps into various types of land and water areas in different weather conditions
 - descent from trees with or without the aid of ropes or other let-down devices
 - swimming and the use of one-person liferafts
 - diving equipment.
- Practice jumps should be supervised by an experienced parachutist and the pilot of the aircraft should have experience as a pilot of an aircraft carrying parachutists. The following precautions should be observed:
 - the aircraft used should be approved for the carrying of parachutists
 - the supervisor should check that each person is correctly dressed and equipped:
 - proper parachute suits, jump-boots, and helmets are worn
 - harnesses, parachutes, and (if carried) rescue packs are correctly fitted
 - reserve chutes are worn
 - rigid face guards are worn for jumps in timber or bush-land and sufficient rope is carried to permit descent from trees
 - lifejackets are worn for jumps near or into water
 - wind speed or wind gusts must not exceed the limits specified for the parachute
 - the jumping point should be determined by the supervisor after dropping a pilot chute or a streamer to determine drift
 - jumps should not be made in close proximity to runways or other hard surfaces

- the jump height should not be less than the altitude required to effect a safe landing under a reserve parachute in the event the main parachute fails to properly open.

Depot Personnel

- At each depot, adequately trained personnel should be assigned to maintain, inspect, pack, and repack liferafts, parachutes, containers, and packs of survival stores and to carry out periodic inspections.
- Depot personnel training should include, where necessary:
 - fitting parachutes to containers, liferafts, etc.
 - joining containers and liferafts for combined drops
 - loading and securing supplies on board aircraft and surface craft
 - stocktaking and replenishing supplies
 - inspections.

Masters and Officers of Merchant Ships

- The mandatory minimum requirements for the training of masters of merchant ships in SAR operations are contained in the **International Convention on Standards of Training, Certification and Watch-keeping for Seafarers, 1978, as amended in 1995.**



Section 3 – On-Scene Co-ordination

Contents

Co-ordination of Search and Rescue Operations

Requirements for Co-ordination	3-1
Co-ordination by Land-Based Authorities	3-1
On-Scene Co-ordination	3-2
Designation of On-Scene Co-ordinator (OSC).....	3-2
OSC Duties	3-3
Designation of Aircraft Co-ordinator (ACO).....	3-4
ACO Duties.....	3-4
Joining Entry Report.....	3-5
SAR Operation Risks.....	3-5

Communications

On-Scene Communications	3-7
OSC Communications with RCC or RSC	
Situation Reports	3-7
RCC and RSC Communications	
Maritime Radio Telex.....	3-9
Maritime Safety Information	3-9
	
Phonetic Alphabet and Figure Code	3-11
Radio Communication Frequencies for Distress Purposes	3-11
Maritime	3-14
Aeronautical	3-14
Land.....	3-14

Planning and Conducting the Search

General.....	3-14
Responsibilities of OSC.....	3-14
Planning the Search	
Datum.....	3-15
Visual Search.....	3-18
Track Spacing.....	3-18
Searching Speed (V).....	3-20
Search Area (A).....	3-20
Search Patterns	
Expanding Square Search (SS).....	3-21
Sector Search (VS).....	3-22
Track Line Search (TS).....	3-25
Parallel Sweep Search (PS).....	3-26
Contour Search (OS).....	3-29
Co-ordinated Vessel–Aircraft Search Pattern.....	3-29
Initiation of Search.....	3-30
Restricted Visibility.....	3-31
Radar Search.....	3-32
Land Search Patterns.....	3-32
Visual Ground Search.....	3-33
SAR Briefing, Debriefing, and Tasking.....	3-34
Further Action on Completion of Initial Phase.....	3-34
Navigational Inaccuracies of Searching Ships.....	3-35
Evidence of Distressed Craft Found.....	3-35
Manoeuvring Instructions.....	3-36
Survival and Emergency Radio Equipment.....	3-37

Conclusion of Search

Search Unsuccessful.....	3-39
Search Successful.....	3-41

Section 3 – On-Scene Co-ordination

Co-ordination of Search and Rescue Operations

■ *Requirements for Co-ordination*

- When a SAR incident occurs, an SMC will normally be designated, within an RCC or RSC. The SMC will obtain SAR facilities, plan SAR operations, and provide overall co-ordination. The SMC may also designate an OSC to provide co-ordination at the scene to carry out plans to locate and rescue survivors. If no SMC has been designated or communications between the SMC and OSC are lost, the OSC may need to perform some additional functions normally handled by an SMC. It may be necessary to designate a vessel OSC for surface activities and an aircraft co-ordinator (ACO) for aircraft activities if vessel-aircraft communications on-scene are not practical.

Note: In practice, the terms RCC and SMC are often used interchangeably due to their close association.

- When a vessel or aircraft becomes aware of a SAR incident directly, it should alert the appropriate RCC or RSC as follows:
 - the RCC or RSC responsible for the SRR where the incident occurred
 - the nearest RCC or RSC
 - any RCC or RSC which can be reached; or
 - any communications facility (e.g., alerting post).
- The first facility to arrive in the vicinity of the SAR incident should assume OSC duties and, if necessary, SMC duties, until an SMC has been designated, and retain OSC duties until the SMC has designated an OSC.
- For the maritime environment, ship masters typically perform the OSC function due to ship endurance on-scene unless more capable SRUs are available.

■ *Co-ordination by Land-Based Authorities*

- SAR operations are normally co-ordinated from specially equipped operational centres or RCCs, staffed 24 hours a day with trained personnel. The working language for these centres should be English.

Section 3 - On-Scene Co-ordination

- Each RCC has an associated SRR. The SRR might be divided into sub-regions with associated RSCs.
- Land-based communication facilities include:
 - land earth stations (LEs)
 - COSPAS-SARSAT Mission Control Centres with Local User Terminals (LUTs)
 - independent CRSs or CRSs associated with the RCCs
 - ATS units
 - mobile phone networks
 - Internet
 - public telephone alerting systems.
- LEs may also be referred to as aeronautical ground earth stations (GESs) or maritime coast earth stations (CESs).

■ ***On-Scene Co-ordination***

- The types of facilities involved in the response and the region of the SAR incident affect on-scene co-ordination.
- Available facilities may include:
 - designated SRUs
 - civil aircraft and vessels, military and naval or other facilities with SAR capability.
- In remote regions, SAR aircraft may not always be available to participate.
- In most oceanic regions, ships will normally be available, depending on shipping density.
- Ships may receive information from land-based SAR authorities or by monitoring distress traffic.
- No advice received from these authorities can set aside the duties of any master as set forth in regulation V/33 of SOLAS 1974 (see appendix A).

■ ***Designation of On-Scene Co-ordinator (OSC)***

- When two or more SAR facilities conduct operations together, the SMC should designate an OSC.
- If this is not practicable, facilities involved should designate, by mutual agreement, an OSC.

- This should be done as early as practicable and preferably before arrival within the search area.
- Until an OSC has been designated, the first facility arriving at the scene should assume the duties of an OSC.
- When deciding how much responsibility to delegate to the OSC, the SMC normally considers the communications and personnel capabilities of the facilities involved.
 - the poorer the communications, the more authority the OSC will need to initiate actions.

■ **OSC Duties**

- Co-ordinate operations of all SAR facilities on-scene.
- Receive the search action plan or rescue plan from the SMC or plan the search or rescue operation, if no plan is otherwise available. (See Planning and Conducting the Search in this section.)
- Modify the search action or rescue action plan as the situation on-scene dictates, keeping the SMC advised (do in consultation with the SMC when practicable).
- Co-ordinate on-scene communications.
- Monitor the performance of other participating facilities.
- Ensure operations are conducted safely, paying particular attention to maintaining safe separations among all facilities, both surface and air.
- Make periodic situation reports (SITREPs) to the SMC. The standard SITREP format may be found in appendix D. SITREPs should include but not be limited to:
 - weather and sea conditions
 - the results of search to date
 - any actions taken
 - any future plans or recommendations.
- Maintain a detailed record of the operation:
 - on-scene arrival and departure times of SAR facilities, other vessels and aircraft engaged in the operation
 - areas searched
 - track spacing used
 - sightings and leads reported

Section 3 - On-Scene Co-ordination

- actions taken
- results obtained.
- Advise the SMC to release facilities no longer required.
- Report the number and names of survivors to the SMC.
- Provide the SMC with the names and designations of facilities with survivors aboard.
- Report which survivors are in each facility.
- Request additional SMC assistance when necessary (for example, medical evacuation of seriously injured survivors).
- **Designation of Aircraft Co-ordinator (ACO)**
 - When multiple aircraft conduct SAR operations, the SMC may designate an ACO in addition to an OSC.
 - If this is not practicable, the OSC may designate an ACO.
 - Generally, the ACO is responsible to the SMC and co-ordinates closely with the OSC.
 - Typically, the SMC or the OSC, as the case may be, would remain in overall charge.
 - When deciding how much responsibility to delegate to the ACO, the SMC considers the mix of radios, radar, and trained personnel capabilities of the facilities involved.
 - The ACO may be a fixed-wing aircraft, a helicopter, a ship, a fixed structure such as an oil rig, or an appropriate land unit.
 - Flight safety of SAR aircraft is a primary concern of the ACO.
- **ACO Duties**
 - Maintain flight safety:
 - maintain safe separation of aircraft
 - ensure common pressure setting used
 - advise the SMC of on-scene weather implications
 - determine aircraft entry and departure points and altitudes
 - filter radio messages to and from SAR aircraft
 - ensure frequencies are used in accordance with SMC directives
 - co-ordinate with adjacent area control centres (ACCs) and airfields.
 - Prioritize and allocate tasks:

- ensure air facilities are aware of the SMC/OSC overall plan
- monitor and report search area coverage
- with appropriate SMC/OSC authority, identify emerging tasks and direct SAR aircraft to meet them.
- Co-ordinate the coverage of search areas:
 - respond to changing factors on-scene and supervise effectiveness of searches
 - co-ordinate aircraft refuelling
 - advise SMC/OSC on maintaining continuity.
- Make periodic consolidated reports (SITREPs) of SAR aircraft to the SMC and the OSC, as appropriate. The standard SITREP format may be found in appendix D.
- Work closely with the OSC:
 - assist in execution of SMC directives
 - maintain communications
 - advise on how the ACO can assist.

■ **Joining Entry Report**

- Airborne SRUs should make a standard joining entry report to the ACO when entering a search and rescue mission area, including:
 - call sign;
 - nationality;
 - type (specify fixed-wing or helicopter and type);
 - position;
 - altitude (on pressure setting used);
 - ETA (at relevant point or search area);
 - endurance on scene; and
 - remarks (specific equipment or limitations).

■ **SAR Operation Risks**

- Safe and effective SAR operations depend on co-ordinated teamwork and sound risk assessment.
- Saving distressed persons, and the safety of assisting personnel, should both be of concern to the OSC.
- The leaders (captain, pilot-in-command, or OSC) must ensure that personnel perform properly as a team with a common mission.

Section 3 – On-Scene Co-ordination

- Mishaps often follow a chain of errors that can start with mistakes made during SAR planning and lead to poor decisions during operations.
- Team safety is supported by:
 - proficiency in keeping everyone informed
 - matching resource capabilities to tasks
 - detecting and avoiding errors early
 - following standard procedures
 - adjusting to non-standard activities.
- Search and rescue action plans provided by the SMC are only guidance for the OSC and SAR facilities on-scene.
 - the OSC may adjust the plans, based on the situation, and inform the SMC (do in consultation with the SMC when practicable)
 - SAR facilities should keep the OSC advised of any difficulties or hazards encountered.
- The risks inherent in any SAR response must be considered against the chances for success and the safety of SAR personnel.
- Some practical concerns for assessing the situation include:
 - is the distressed craft in immediate danger of causing harm or placing the rescue facility in jeopardy?
 - can the rescue facility handle the weather conditions?
 - has the distressed craft given enough information to prepare the assisting vessel to aid in the rescue?
 - can the assisting facility realistically be of assistance?
 - if recovery of a large number of survivors is a factor:
 - can the rescue facility accommodate them in regards to food, shelter, clothing, living space?
 - will the craft performing the rescue be stable with the survivors on-board?
 - if helicopter operations are a factor:
 - is the vessel's construction suitable for a vessel-aircraft joint operation?
 - does the rescue facility have enough crew members available to assist?

Communications

■ On-Scene Communications

The OSC should ensure that reliable communications are maintained on-scene.

- Normally, the SMC will select SAR-dedicated frequencies for use on-scene, inform the OSC or SAR facilities, and establish communications with adjacent RCCs and parent agencies of SAR facilities as appropriate.
 - the OSC should maintain communications with all SAR facilities and the SMC
 - a primary and secondary frequency should be assigned for on-scene communications.
- SAR facilities should report to the OSC on an assigned frequency.
 - if a frequency shift is carried out, instructions should be provided about what to do if intended communications cannot be re-established on the new frequency
 - all SAR facilities should carry a copy of the *International Code of Signals (INTERCO)*, which contains communications information internationally recognized by aircraft, vessels, and survivors.

■ OSC Communications with RCC or RSC

Situation Reports

- The OSC uses SITREPs to keep the SMC informed of on-scene mission progress and conditions, and addresses SITREPs to the SMC unless otherwise directed. Search facilities use SITREPs to keep the OSC informed.
 - the SMC uses SITREPs to keep superiors, other RCCs and RSCs, and any other interested agencies informed
 - where pollution or threat of pollution exists from the vessel or aircraft casualty, the agency tasked with environmental protection should be an information addressee on all SITREPs
 - provide earliest notice of an emergency (short form)
 - pass urgent essential details when requesting assistance (short form)
 - pass amplifying or updating information during SAR operations (full form).

Section 3 – On-Scene Co-ordination

- Initial SITREPs should be transmitted as soon as details of an incident become clear enough to indicate SAR involvement.
 - SITREPs should not be delayed unnecessarily for confirmation of all details
 - further SITREPs should be issued as soon as other relevant information is obtained
 - information already passed should not be repeated
 - during prolonged operations, “no change” SITREPs should be issued at intervals of about three hours to reassure recipients that nothing has been missed
 - when the incident is concluded, a “final” SITREP should be issued as confirmation.
- A standard SITREP format is shown in appendix D.
 - each SITREP concerning the same incident should be numbered sequentially.
- SITREPs prepared on-scene usually provide the following information:

Identification

- usually in the subject line
- the SITREP number
- identification of the distressed craft
- a one- or two-word description of the emergency
- numbered sequentially throughout the case
- when an OSC is relieved on-scene, the new OSC continues the SITREP numbering sequence

Situation

- a description of the case
- the conditions that affect the case
- any amplifying information that will clarify the problem
- after the first SITREP, only changes to the original reported situation need be included

Action taken

- a report of all action taken since the last report, including results of such action
- when an unsuccessful search has been conducted, the report includes:
 - the areas searched
 - hours searched
 - factors that may have decreased search effectiveness, such as weather or equipment difficulties

Future plans

- description of actions planned for future execution
- recommendations
- request for additional assistance

Status of case

- this is normally used only on the final SITREP to indicate that the case is closed or that search is suspended pending further developments.

■ ***RCC and RSC Communications***

Maritime Radio Telex

- RCCs and RSCs may use radio telex for shore-to-ship distress traffic.
- Radio telex is sometimes called radio teletype (RTT) or narrow-band direct printing (NBDP).
- Telex messages may be sent via satellite or terrestrial radio.
- Radio telex services should be indicated in the International Telecommunication Union (ITU) *List of Coast Stations*.
- Shore-to-ship telex messages are on predetermined frequencies, and mostly at predetermined times.
 - the frequencies for radio telex are:
 - 490 kHz,
 - 518 and 4209.5 kHz (international NAVTEX)
 - 2174.5 kHz.

Maritime Safety Information

- NAVTEX is used to promulgate navigation and safety warnings to vessels, and may be used by SAR personnel for SAR-related broadcasts.

Section 3 – On-Scene Co-ordination

- The World Wide Navigational Warning System (WWNWS) is for long-range NAVAREA warnings and coastal NAVTEX warnings.
 - It provides for globally co-ordinated transmissions with NAVAREA Co-ordinators for each NAVAREA.
 - Warnings which SAR personnel may send over WWNWS include:
 - distress alerts
 - information about overdue or missing aircraft or vessels.
 - Collectively, these types of alerts, combined with navigation and meteorological warnings, are called maritime safety information (MSI).
- Inmarsat is also used to broadcast MSI via SafetyNET.
- SafetyNET provides an automatic, global method of broadcasting SAR messages to vessels in both fixed and variable geographic areas. A similar service of Inmarsat called FleetNET can be used to send shore-to-ship messages to predetermined groups of vessels.
- RCCs normally relay distress alerts over both NAVTEX and SafetyNET.
- Normally, SAR broadcasts over SafetyNET are sent to all vessels within a desired radius of a specified position.
- It may be faster to first see whether an appropriate ship can be identified via a ship reporting system, and contacted, before doing a SAR broadcast.

Phonetic Alphabet and Figure Code

- The phonetic alphabet and figure code is sometimes necessary to use when speaking or spelling out call signs, names, search area designations, abbreviations, etc.
- For a complete listing of the phonetic alphabet, figure code, and Morse signals, obtain a copy of the *International Code of Signals*.

Radio Communication Frequencies for Distress Purposes

- The frequencies in the following tables are available for safety purposes, distress communications, and SAR operations.

Alerting, SAR operations, maritime safety, distress and safety, and survival craft frequencies

Function	System	Frequency	
Alerting	406 MHz EPIRB	406–406.1 MHz (earth-to-space)	
	Inmarsat-E EPIRB	1644.3–1644.5 MHz (earth-to-space)	
	Inmarsat SES	1544–1545 MHz (space-to-earth)	
		1626.5–1646.5 MHz (earth-to-space)	
		1645.6–1645.8 MHz (earth-to-space)	
	VHF DSC (Channel 70)	156.525 MHz ¹	
	MF/HF DSC ²	2187.5 kHz ³	4207.5 kHz
		8414.5 kHz	12577 kHz
		16804.5 kHz	
	VHF AM	121.5 MHz	
	VHF FM (Channel 16)	156.8 MHz	
On-scene communications	VHF Channel 16	156.8 MHz	
	MF Radiotelephony	2182 kHz	
	MF NBDP	2174.5 kHz	
Communications involving aircraft	On-scene, including SAR radiotelephony	156.8 MHz ⁴	121.5 MHz ⁵
		123.1 MHz	156.3 MHz
		2182 kHz	3023 kHz
		4125 kHz	5680 kHz ⁶
Homing signals	406 MHz EPIRB	121.5 MHz	
	9 GHz radar transponders	9200–9500 MHz	
Maritime safety information (MSI)	NAVTEX Warnings NBDP	518 kHz ⁷	
		490 kHz ⁸	4209.5 kHz ⁹
		4210 kHz	6314 kHz
		8416.5 kHz	12579 kHz
		16806.5 kHz	19680.5 kHz
		22376 kHz	26100.5 kHz
	Satellite SafetyNET	1530–1545 MHz (space-to-earth)	
Safety of navigation	VHF Channel 13	156.650 MHz	

Section 3 - On-Scene Co-ordination

Alerting, SAR operations, maritime safety, distress and safety, and survival craft frequencies (continued)

Function	System	Frequency
Distress and safety traffic	Satellite	1530-1544 MHz (space-to-earth) & 1626.5-1646.5 MHz (earth-to-space)
	Radiotelephony	2182 kHz 4125 kHz
		6215 kHz 8291 kHz
		12290 kHz 16420 kHz
		156.8 MHz
NBDP	2174.5 kHz 4177.5 kHz 6268 kHz 8376.5 kHz 12520 kHz 16695 kHz	
Survival craft	VHF Radiotelephony	156.8 MHz & one other frequency in the 156-174 MHz band
	9 GHz radar transponders	9200-9500 MHz

- ¹ Frequency 156.525 MHz is used for ship-to-ship alerting and, if within sea area A1, for ship-to-shore alerting.
- ² For ships equipped with MF/HF DSC equipment, there is a watch requirement on 2187.5 kHz, 8414.5 kHz, and one other frequency.
- ³ Frequency 2187.5 kHz is used for ship-to-ship alerting and, if within sea areas A2, for ship-to-shore alerting.
- ⁴ Frequencies 156.3 and 156.8 MHz may also be used by aircraft for safety purposes only.
- ⁵ Frequency 121.5 MHz may be used by ships for distress and urgency purposes.
- ⁶ The priority of use for ship-aircraft communication is 4125 kHz. Additionally, frequencies 123.1 MHz, 3023 kHz, and 5680 kHz may be used for intercommunication between mobile stations and these stations and participating land stations engaged in co-ordinated search and rescue operations.
- ⁷ The international NAVTEX frequency 518 kHz is the primary frequency for the transmission by coast stations of maritime safety information by NBDP. The other frequencies are used only to augment the coverage or information provided on 518 kHz.
- ⁸ Frequency 490 kHz cannot be used for MSI employing NBDP transmission until 1 February 1999.
- ⁹ Frequency 4209.5 kHz is not used by all States.

Frequencies for use in the GMDSS

DSC distress & safety calling	Radiotelephony distress & safety traffic	NBDP distress & safety traffic
2187.5 kHz	2182.0 kHz	2174.5 kHz
4027.5 kHz	4125.0 kHz	4177.5 kHz
6312.0 kHz	6215.0 kHz	6268.0 kHz
8414.5 kHz	8291.0 kHz	8376.5 kHz
12577.0 kHz	12290.0 kHz	12520.0 kHz
16804.5 kHz	16420.0 kHz	16695.0 kHz
156.525 MHz (VHF Channel 70)	156.8 MHz (VHF Channel 16)	
MSI NBDP Broadcasts by coast radio and earth stations		
490.0 kHz*	518.0 kHz	
4209.5 kHz†	4210.0 kHz	
6314.0 kHz	8516.5 kHz	
12579.0 kHz	16806.5 kHz	
19680.5 kHz	22376.0 kHz	26100.5 kHz
On-scene search & rescue radiotelephony		
2182.0 kHz (R/T)		
3023.0 kHz (Aeronautical frequency)		
4125.0 kHz (R/T)		
5680.0 kHz (Aeronautical frequency)		
123.1 MHz (Aeronautical frequency)		
156.8 MHz (VHF Channel 16)		
156.5 MHz (VHF Channel 10)		
156.3 MHz (VHF Channel 6)		
Locating/homing signals		
121.5 MHz (Cospas-Sarsat satellite location & aircraft homing)		
156–174 MHz (VHF maritime band – radiotelephony)		
406.025 MHz (Cospas-Sarsat satellite location)		
9200 to 9500 MHz (X-band radar transponders – SART)		

* For use after full implementation of GMDSS (1 February 1999).

† NAVTEX service (coastal maritime safety information).

Maritime

- Ships transmitting a distress message on any of the above frequencies should use the appropriate alarm signals before transmitting the message until contact has been established.

Aeronautical

- The aeronautical frequencies 3023 kHz and 5680 kHz may be used for communications by ships and participating CRSs engaged in co-ordinated SAR operations. However, since these frequencies are not continuously monitored, shore authorities may be needed to help establish communications on these frequencies.

Land

- Land SAR can be conducted for many types of incidents, ranging from a downed aircraft to a hiker lost in the wilderness. Land facilities and aeronautical facilities may conduct co-ordinated land searches. Since each normally operates on different radio frequencies, advance co-ordination amongst local agencies may be necessary to establish effective communications.
 - Aircraft typically have at least one radio, so it may be easiest for the air facility and land facility to use an aeronautical frequency.
 - If the land facility does not have a portable aircraft radio, then communications may be provided by equipping an aircraft with a radio operating on ground frequencies.

Planning and Conducting the Search

■ General

- For surface and aircraft facilities to search effectively, search patterns and procedures must be pre-planned so ships and aircraft can co-operate in co-ordinated operations with the minimum risks and delay.
- Standard search patterns have been established to meet varying circumstances.

■ Responsibilities of OSC

- The OSC should obtain a search action plan from the SMC via the RCC or RSC as soon as possible. Normally, search planning is performed using trained personnel, advanced search planning

techniques, and information about the incident or distressed craft not normally available to the OSC. However, the OSC may still need to plan a search under some circumstances. Search operations should commence as soon as facilities are available at the scene. If a search plan has not been provided by the SMC, the OSC should do the planning until an SMC assumes the search planning function. Simplified techniques are presented below.

- Modify search plans based on changes in the on-scene situation, such as:
 - arrival of additional assisting facilities
 - receipt of additional information
 - changes in weather, visibility, lighting conditions, etc.
- In case of language difficulties, the *International Code of Signals* and *IMO Standard Marine Communication Phrases* should be used.
- On assuming the duty, the OSC should inform the appropriate CRS or ATS unit and keep it informed of developments at regular intervals.
- The OSC should keep the SMC informed at regular intervals and whenever the situation has changed.

■ **Planning the Search**

Datum

- It will be necessary to establish a datum, or geographic reference, for the area to be searched. The following factors should be considered:
 - reported position and time of the SAR incident
 - any supplementary information such as DF bearings or sightings
 - time interval between the incident and the arrival of SAR facilities
 - estimated surface movements of the distressed craft or survival craft, depending on drift (The two figures following this discussion are used in calculating drift.) The datum position for the search is found as follows:
 - drift has two components: leeway and total water current
 - leeway direction is downwind
 - leeway speed depends on wind speed

Section 3 - On-Scene Co-ordination

- the observed wind speed when approaching the scene may be used for estimating leeway speed of liferafts by using the graph following this discussion (Persons in the water (PIW) have no leeway while liferaft stability and speed vary with or without drogue or ballast.)
 - total water current may be estimated by computing set and drift when approaching the scene
 - drift direction and speed is the vector sum of leeway and total water current
- drift distance is drift speed multiplied by the time interval between the incident time, or time of the last computed datum, and the commence search time
- datum position is found by moving from the incident position, or last computed datum position, the drift distance in the drift direction and plotting the resulting position on a suitable chart.

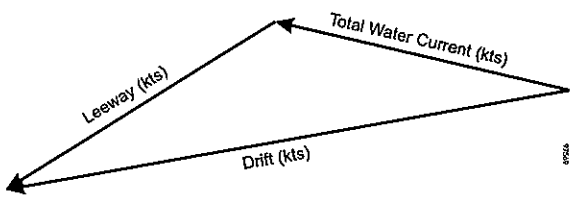

Computing drift speed and direction from total water current and leeway

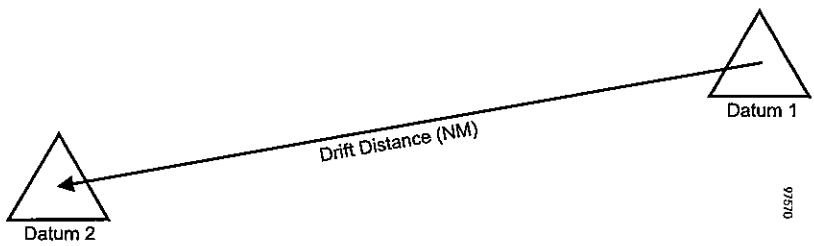

**Determining a new datum
(drift distance = drift speed × drift time)**

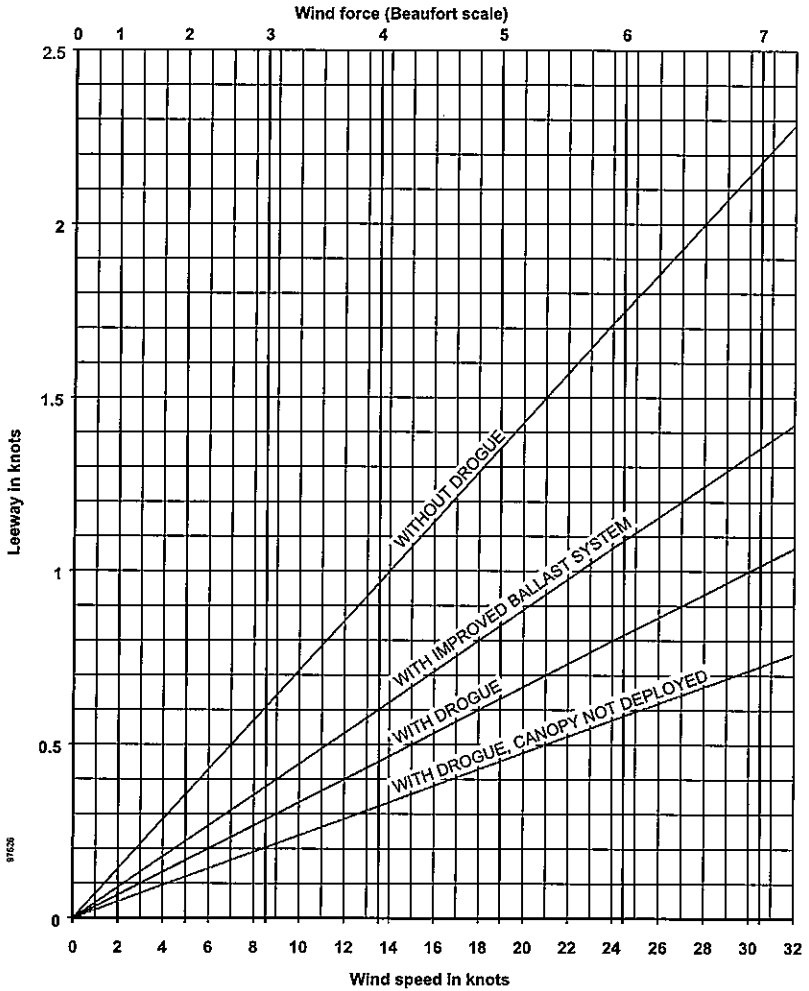

Liferaft leeway

Visual Search

- Individual search patterns have been designed so that an OSC can rapidly initiate a search by one or more craft.
- There will be a number of variables that cannot be foreseen. Search patterns based on visual search have been established which should meet many circumstances. They have been selected for simplicity and effectiveness and are discussed later in this section.

Track Spacing

- Most search patterns consist of parallel tracks or sweeps covering a rectangular area. The distance between adjacent tracks is called the track spacing.
- Recommended uncorrected track spacings for merchant vessels are provided in the table following this discussion. Correction factors based on weather conditions and search object are provided in the table after the track spacing table. Multiplying the uncorrected track spacing (S_u) by the appropriate weather correction factor (f_w) produces the recommended track spacing (S):

$$S = S_u \times f_w$$

- Changes in weather, number of assisting craft, etc., may occur, making it prudent to alter the track spacing.
- The SMC must ensure that all searching ships and aircraft maintain safe separations from one another and accurately follow their assigned search patterns.

Recommended track spacing (S_u) for merchant vessels

Search object	Meteorological visibility (nautical miles)				
	3	5	10	15	20
Person in water	0.4	0.5	0.6	0.7	0.7
4-person liferaft	2.3	3.2	4.2	4.9	5.5
6-person liferaft	2.5	3.6	5.0	6.2	6.9
15-person liferaft	2.6	4.0	5.1	6.4	7.3
25-person liferaft	2.7	4.2	5.2	6.5	7.5
Boat <5 m (17 ft)	1.1	1.4	1.9	2.1	2.3
Boat 7 m (23 ft)	2.0	2.9	4.3	5.2	5.8
Boat 12 m (40 ft)	2.8	4.5	7.6	9.4	11.6
Boat 24 m (79 ft)	3.2	5.6	10.7	14.7	18.1

- The track spacings shown in the table above are recommended for use with all the search patterns shown in this Volume except for the sector search pattern.
- The table takes into account the type of search object and the meteorological visibility.
- Other factors may also be considered, including sea conditions, time of day, position of the sun, effectiveness of observers, etc.

Sweep widths for helicopters (km (NM))

Search object	Meteorological visibility (km (NM))		
	1.9 (1)	9.3 (5)	>37 (>20)
Person in water	0.0 (0.0)	0.2 (0.1)	0.2 (0.1)
4-person liferaft	0.9 (0.5)	3.1 (1.7)	5.4 (2.9)
8-person liferaft	0.9 (0.5)	3.9 (2.1)	7.0 (3.8)
15-person liferaft	1.1 (0.6)	4.4 (2.4)	8.3 (4.5)
25-person liferaft	1.1 (0.6)	5.2 (2.8)	10.6 (5.7)
Boat <5 m (17 ft)	0.9 (0.5)	3.0 (1.6)	4.6 (2.5)
Boat 6 m (20 ft)	1.3 (0.7)	5.6 (3.0)	10.9 (5.9)
Boat 10 m (33 ft)	1.3 (0.7)	7.2 (3.9)	16.9 (9.1)
Boat 24 m (80 ft)	1.5 (0.8)	10.6 (5.7)	34.3 (18.5)

Sweep widths for fixed-wing aircraft (km (NM))

Search object	Meteorological visibility (km (NM))		
	1.9 (1)	9.3 (5)	>37 (>20)
Person in water	0.0 (0.0)	0.2 (0.1)	0.2 (0.1)
4-person liferaft	0.6 (0.3)	2.4 (1.3)	4.3 (2.3)
8-person liferaft	0.7 (0.4)	3.1 (1.7)	5.6 (3.0)
15-person liferaft	0.7 (0.4)	3.7 (2.0)	6.9 (3.7)
25-person liferaft	0.7 (0.4)	4.3 (2.3)	8.7 (4.7)
Boat <5 m (17 ft)	0.7 (0.4)	2.4 (1.3)	3.7 (2.0)
Boat 6 m (20 ft)	0.9 (0.5)	4.6 (2.5)	9.3 (5.0)
Boat 10 m (33 ft)	0.9 (0.5)	6.3 (3.4)	14.4 (7.8)
Boat 24 m (80 ft)	1.1 (0.6)	9.4 (5.1)	30.9 (16.7)

Weather correction factors (f_w) for all types of search units

Weather Winds km/h (kts) or seas m (ft)	Search object	
	Person in water	Liferaft
Winds 0–28 km/h (0–15 kt) or seas 0–1 m (0–3 ft)	1.0	1.0
Winds 28–46 km/h (15–25 kt) or seas 1–1.5 m (3–5 ft)	0.5	0.9
Winds >46 km/h (>25 kt) or seas >1.5 m (>5 ft)	0.25	0.6

Searching Speed (V)

- To carry out a parallel sweep search in a co-ordinated manner, all facilities should proceed at the same speed, as directed by the OSC.
- This should normally be the maximum speed of the slowest ship present.
- In restricted visibility, the OSC will normally order a reduction in searching speed.

Search Area (A)

- Compute the search radius (R), using one of the following two methods:
 - if the search must commence immediately, assume $R = 10$ NM
 - if time is available for computation:
 - compute the area a craft can cover in a certain amount of time (T) by the formula:

$$A = S \times V \times T$$

- the total amount of area (A_t) which can be covered by several craft is the sum of the areas each craft can cover:

$$A_t = A_1 + A_2 + A_3 + \dots$$

if all craft are searching at the same speed for the same amount of time, then:

$$A_t = N \times A$$

where N is the number of search craft

- the search radius (R) of the circle is one-half the square root of the search area:

$$R = \frac{\sqrt{A_t}}{2}$$

- Plot the search area:

- draw a circle centred on datum with radius R .
- using tangents to the circle, form a square as shown below
- if several facilities will be searching at the same time, divide the square into sub-areas of the appropriate size and assign search facilities accordingly.

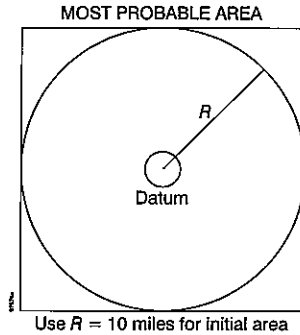

■ Search Patterns

Expanding Square Search (SS)

- Most effective when the location of the search object is known within relatively close limits.
- The commence search point is always the datum position.
- Often appropriate for vessels or small boats to use when searching for persons in the water or other search objects with little or no leeway.
- Due to the small area involved, this procedure must not be used simultaneously by multiple aircraft at similar altitudes or by multiple vessels.
- Accurate navigation is required; the first leg is usually oriented directly into the wind to minimize navigational errors.
- It is difficult for fixed-wing aircraft to fly legs close to datum if S is less than 2 NM.

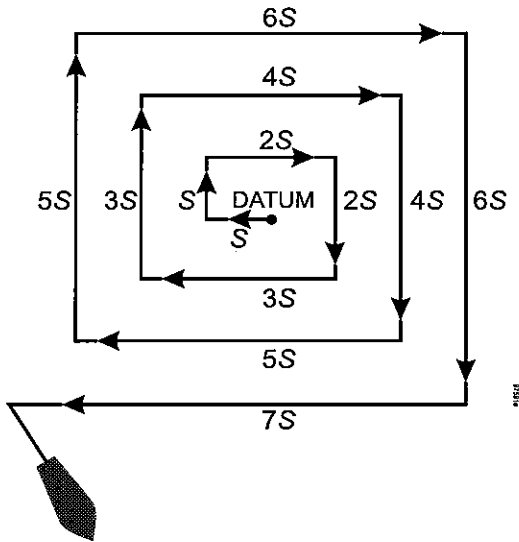

Expanding square search (SS)

Sector Search (VS)

- Most effective when the position of the search object is accurately known and the search area is small.
- Used to search a circular area centred on a datum point.
- Due to the small area involved, this procedure must not be used simultaneously by multiple aircraft at similar altitudes or by multiple vessels.
- An aircraft and a vessel may be used together to perform independent sector searches of the same area.
- A suitable marker (for example, a smoke float or a radio beacon) may be dropped at the datum position and used as a reference or navigational aid marking the centre of the pattern.
- For aircraft, the search pattern radius is usually between 5 NM and 20 NM.
- For vessels, the search pattern radius is usually between 2 NM and 5 NM, and each turn is 120°, normally turned to starboard.

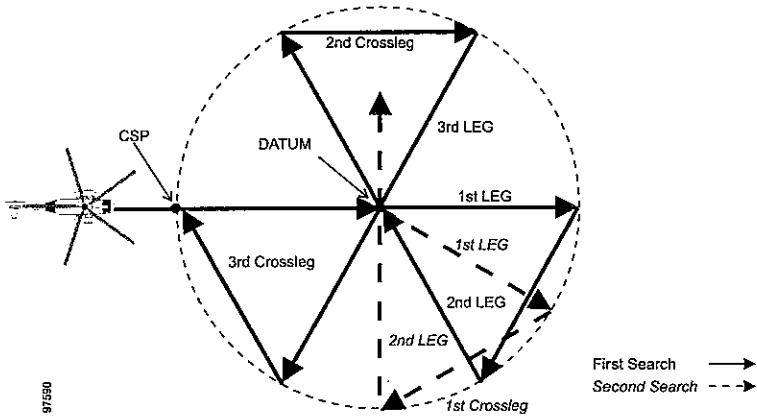

Sector pattern: single-unit (VS)

**Sector search computations: time to complete one leg (t)
in minutes and seconds**

Radius	Speed								
	3 kt	5 kt	8 kt	10 kt	15 kt	20 kt	60 kt	80 kt	90 kt
0.5 NM	10:00	6:00	3:45	3:00	2:00	1:30	0:30	0:22.5	0:20
1.0 NM	20:00	12:00	7:30	6:00	4:00	3:00	1:00	0:45	0:40
1.5 NM	30:00	18:00	11:15	9:00	6:00	4:30	1:30	1:07.5	1:00
2.0 NM	40:00	24:00	15:00	12:00	8:00	6:00	2:00	1:30	1:20
2.5 NM	50:00	30:00	18.45	15:00	10:00	7:30	2:30	1:55.5	1:40
3.0 NM	60:00	36:00	22:30	18:00	12:00	9:00	3:00	2:18	2:00
3.5 NM		42:00	26:15	21:00	14:00	10:30	3:30	2:40.5	2:20
4.0 NM		48:00	30:00	24:00	16:00	12:00	4:00	3:03	2:40
4.5 NM		54:00	33:45	27:00	18:00	13:30	4:30	3:25.5	3:00
5.0 NM		60:00	37:30	30:00	20:00	15:00	5:00	3:48	3:20
6.0 NM			45:00	36:00	24:00	18:00	6:00	4:33	4:00
7.0 NM			52:30	42:00	28:00	21:00	7:00	5:18	4:40
8.0 NM			60:00	48:00	32:00	24:00	8:00	6:03	5:20

Note: Interpolation may be used with this table.

Section 3 - On-Scene Co-ordination

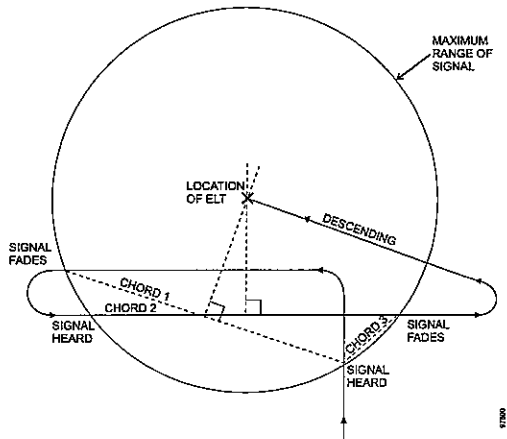

Map-assisted aural electronic search

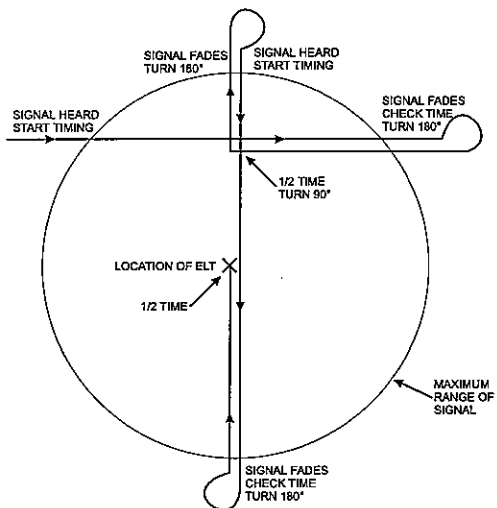

Time-assisted aural electronic search

Sweep widths for visual land search (km (NM))

Search object	Height (m (ft))	Visibility (km (NM))				
		6 (3)	9 (5)	19 (10)	28 (15)	37 (20)
Person	150 (500)	0.7 (0.4)	0.7 (0.4)	0.9 (0.5)	0.9 (0.5)	0.9 (0.5)
	300 (1000)	0.7 (0.4)	0.7 (0.4)	0.9 (0.5)	0.9 (0.5)	0.9 (0.5)
	450 (1500)	–	–	–	–	–
	600 (2000)	–	–	–	–	–
Vehicle	150 (500)	1.7 (0.9)	2.4 (1.3)	2.4 (1.3)	2.4 (1.3)	2.4 (1.3)
	300 (1000)	1.9 (1.0)	2.6 (1.4)	2.6 (1.4)	2.8 (1.5)	2.8 (1.5)
	450 (1500)	1.9 (1.0)	2.6 (1.4)	3.1 (1.7)	3.1 (1.7)	3.1 (1.7)
	600 (2000)	1.9 (1.0)	2.8 (1.5)	3.7 (2.0)	3.7 (2.0)	3.7 (2.0)
Aircraft less than 5700 kg	150 (500)	1.9 (1.0)	2.6 (1.4)	2.6 (1.4)	2.6 (1.4)	2.6 (1.4)
	300 (1000)	1.9 (1.0)	2.8 (1.5)	2.8 (1.5)	3.0 (1.6)	3.0 (1.6)
	450 (1500)	1.9 (1.0)	2.8 (1.5)	3.3 (1.8)	3.3 (1.8)	3.3 (1.8)
	600 (2000)	1.9 (1.0)	3.0 (1.6)	3.7 (2.0)	3.7 (2.0)	3.7 (2.0)
Aircraft over 5700 kg	150 (500)	2.2 (1.2)	3.7 (2.0)	4.1 (2.2)	4.1 (2.2)	4.1 (2.2)
	300 (1000)	3.3 (1.8)	5.0 (2.7)	5.6 (3.0)	5.6 (3.0)	5.6 (3.0)
	450 (1500)	3.7 (2.0)	5.2 (2.8)	5.9 (3.2)	5.9 (3.2)	5.9 (3.2)
	600 (2000)	4.1 (2.2)	5.2 (2.9)	6.5 (3.5)	6.5 (3.5)	6.5 (3.5)

Track Line Search (TS)

- Normally used when an aircraft or vessel has disappeared without a trace along a known route.
- Often used as initial search effort due to ease of planning and implementation.
- Consists of a rapid and reasonably thorough search along intended route of the distressed craft.
- Search may be along one side of the track line and return in the opposite direction on the other side (TSR).
- Search may be along the intended track and once on each side, then search facility continues on its way and does not return (TSN).
- Aircraft are frequently used for TS due to their high speed.

Section 3 – On-Scene Co-ordination

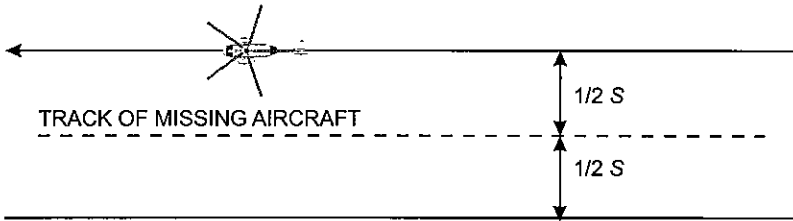

Track line search, return (TSR)

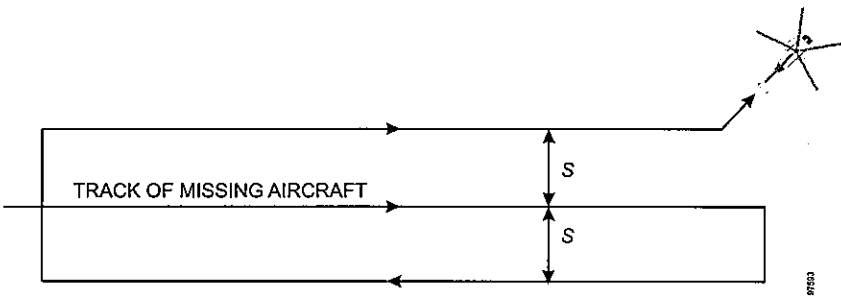

Track line search, non-return (TSN)

- Aircraft search height usually 300 m to 600 m (1000 ft to 3000 ft) during daylight or 600 m to 900 m (2000 ft to 3000 ft) at night.

Parallel Sweep Search (PS)

- Used to search a large area when survivor location is uncertain.
- Most effective over water or flat terrain.
- Usually used when a large search area must be divided into sub-areas for assignment to individual search facilities on-scene at the same time.
- The commence search point is in one corner of the sub-area, one-half track space inside the rectangle from each of the two sides forming the corner.
- Search legs are parallel to each other and to the long sides of the sub-area.

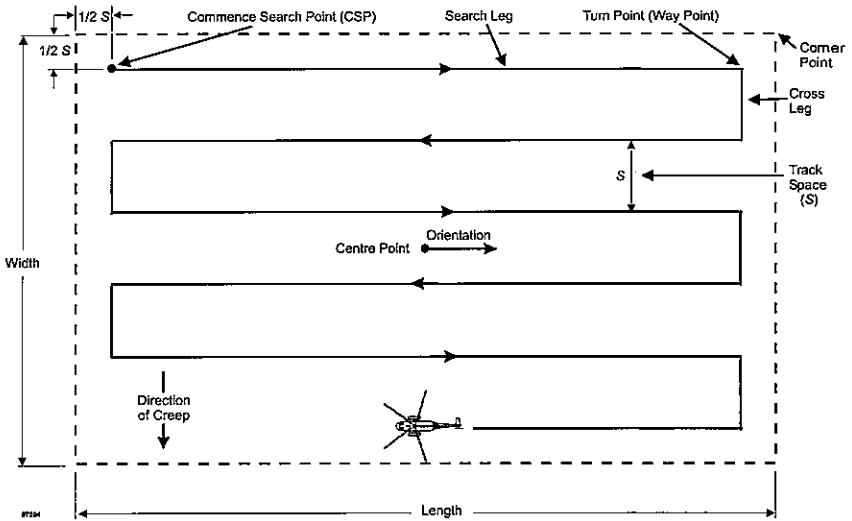

Parallel sweep search (PS)

- Multiple vessels may be used as shown on page 3-28:
 - Parallel sweep: for use by two ships.
 - Parallel sweep: for use by three ships.
 - Parallel sweep: for use by four ships.
 - Parallel sweep: for use by five or more ships.

Section 3 - On-Scene Co-ordination

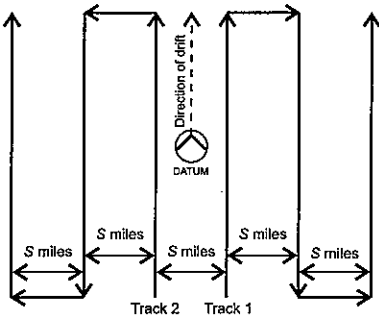

PATTERN 2
Parallel track search - 2 ships

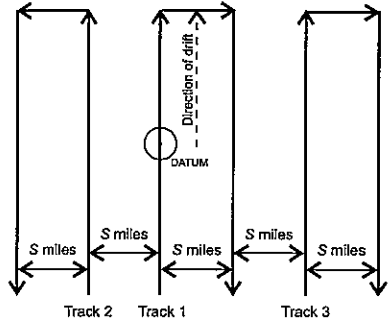

PATTERN 3
Parallel track search - 3 ships

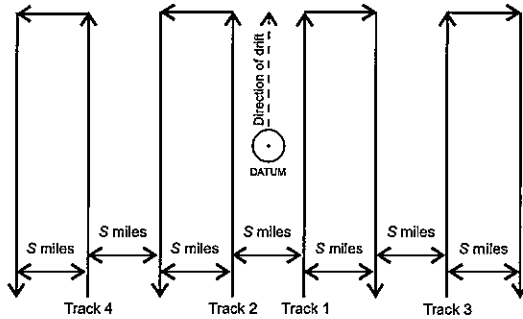

PATTERN 4
Parallel track search - 4 ships

97658

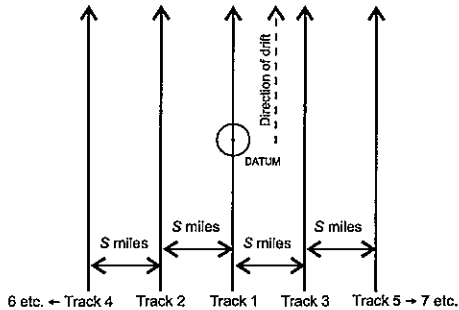

PATTERN 5
Parallel track search - 5 or more ships

Contour Search (OS)

- Used around mountains and in valleys when sharp changes in elevation make other patterns not practical.
- Search is started from highest peak and goes from top to bottom with new search altitude for each circuit.
- Search altitude intervals may be 150 m to 300 m (500 ft to 1000 ft).
- The aircraft may make a descending orbit away from the mountain before resuming the contour search at the lower altitude.
- The aircraft may spiral downwards around the mountain at a low but approximately constant rate of descent when there is not enough room to make a circuit opposite to the direction of search.
- If the mountain cannot be circled, successive sweeps at the same altitude intervals as listed above should be flown along its side.
- Valleys are searched in circles, moving the centre of the circuit one track spacing after each completed circuit.

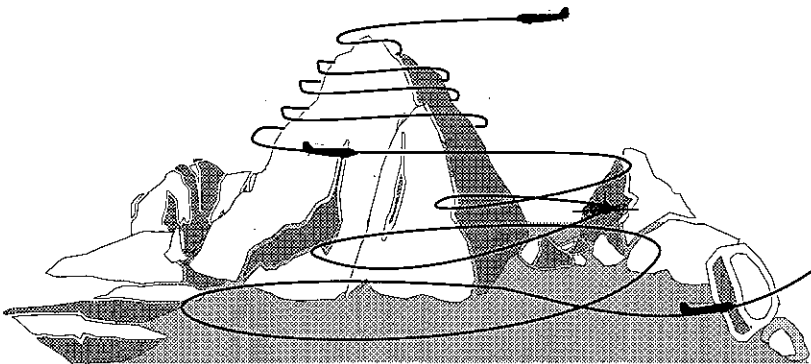

Contour search (OS)

Co-ordinated Vessel–Aircraft Search Pattern

- Normally used only if there is an OSC present to give direction to and provide communications with the participating craft.
- Creeping line search, co-ordinated (CSC) is often used.

Section 3 – On-Scene Co-ordination

- The aircraft does most of the searching, while the ship steams along a course at a speed as directed by the OSC so that the aircraft can use it as a navigational checkpoint.
- The aircraft, as it passes over the ship, can easily make corrections to stay on the track of its search pattern.
- Gives a higher probability of detection than can normally be attained by an aircraft searching alone.
- Ship speed varies according to the speed of the aircraft and the size of the pattern. The relationship among the speed of the surface facility, the aircraft's speed, the track spacing and the length of the search legs is defined by the following equation:

$$V_s = (S \times V_a) / (L + S),$$

where V_s is the speed of the surface facility in knots, S is the track spacing in nautical miles, V_a is the aircraft's true air speed (TAS) in knots, and L is the length of the aircraft's search leg in nautical miles.

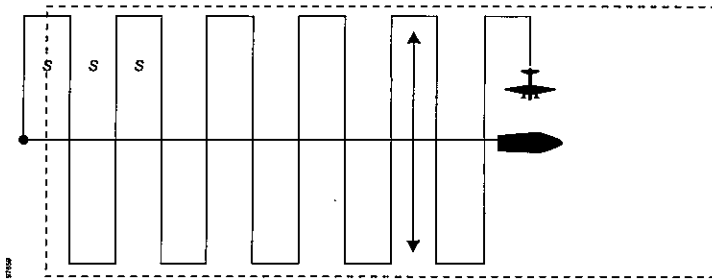

Creeping line search, co-ordinated (CSC)

■ *Initiation of Search*

- When a search facility arrives on-scene in advance of the others, it should proceed directly to datum and commence an expanding square search.
- If possible, datum may be marked by putting over a liferaft or other floating marker with a leeway similar to that of the search object, as a check on the drift.

- This can then be used as a datum marker throughout the search.
- As other facilities arrive, the OSC should select one of the search patterns, as appropriate, and allocate search sub-areas to individual facilities.
- In good visibility and with sufficient search facilities, the OSC may let the first facility continue its expanding square search while the others conduct a parallel track search through the same area.
- In restricted visibility, or if sufficient search facilities are not available, it will probably be better to have the first facility break off the expanding square search and be available for initiation of a parallel sweep search.

■ **Restricted Visibility**

- A parallel sweep search in restricted visibility poses problems because of the following considerations:
 - desirability of reducing the interval between SAR facilities as much as possible consistent with safety
 - resulting loss of search area coverage
 - potential risk of collision.
- During restricted visibility, the OSC should direct a reduction of vessel speed as necessary.
- In such circumstances, any ship not fitted with radar, or whose radar has become defective, should consider dropping astern of other ships, informing the OSC of its action.
 - the ship's search should continue when it judges its position (relative to other searching ships) is safe to do so
 - if there is a reduction in visibility and ships have already started to carry out a search pattern, the OSC may decide that the safest action would be to continue the pattern in force despite the resulting loss of coverage.
- Should it be necessary for the OSC to consider initiating any of the patterns during conditions of restricted visibility, the following factors should be considered:
 - ships will be proceeding at a reduced speed and searches will take longer
 - to search the area thoroughly in such conditions must mean a reduction in track spacing

Section 3 – On-Scene Co-ordination

- reduction in track spacing would require a reduction in the interval between SAR facilities and, thus, the carrying out of more sweeps.
- The OSC may decide to accept a reduction in the area searched and should have regard to the direction and rate of estimated drift in deciding whether to accept a reduction in one or both of the length and width of the search area.
- If visibility improves, the OSC should initiate such actions as will best make good the lost coverage which has taken place.

■ **Radar Search**

- When several assisting ships are available, a radar search may be effective, especially when the position of the incident is not known reliably and SAR aircraft may not be available.
- No prescribed pattern has been provided for this contingency.
- The OSC should normally direct ships to proceed in "loose line abreast", maintaining a track spacing between ships of the expected detection range multiplied by $1\frac{1}{2}$.
- The table below serves as a guide for detection ranges for ship radar.

Search object	Radar scanner height	
	15 m	30 m
10000 gt ship	13.0 NM	18.0 NM
1000 gt ship	6.0 NM	8.4 NM
200 gt ship	5.5 NM	7.7 NM
9 m boat	1.9 NM	2.7 NM

■ **Land Search Patterns**

- Aircraft search over land differs from maritime searching in that it is usually more difficult to locate search objects.
- Repeated aircraft searches of an area are often necessary.
- Search of large areas by ground facilities alone is usually not practical but may be effective for close examination of a small area.

■ **Visual Ground Search**

- Use obvious natural or artificial landmarks such as rivers or roads to delimit search sub-areas.
- Land search facilities should be equipped with large-scale topographical maps with search areas marked on them.
- Land search facility patterns are normally parallel sweeps or contour searches using a line-abreast formation.
- Track spacing for lost persons is normally between five and eight metres.
- Search progress should be slow through wooded areas. One square kilometre of woods can be searched by 20 to 25 persons in about 1.5 hours.
- *The parallel sweep search:*
 - team leader, two flankers on end of each line, and as many searchers as the terrain will allow
 - search line is first formed along the search area boundary
 - if an obstacle or an item of interest is encountered, the team stops and waits for results of the investigation before the entire search line moves forward again
 - boundary control of each successive sweep through an area is assigned to the pivoting flanker
 - track spacing between each searcher is determined by the distance a person can effectively search while keeping adjacent searchers in visual and audible contact
 - on first leg of search, one flanker will follow a natural boundary or predetermined compass course while the other flanker marks a trail at the other end to follow after the pivot is made
 - if contact is lost with a searcher, the team leader must be notified and the search line stopped until complete team contact is re-established.
- *The contour search:*
 - used when mountainous features can be circled completely
 - pattern is a modified parallel sweep
 - search begins with one flanker at the highest level and the other flanker at the low end of the line

Section 3 – On-Scene Co-ordination

- when the mountain is circled once, the search line is re-formed on the lower side of the bottom flanker
- general procedures for a parallel sweep search are followed.

■ **SAR Briefing, Debriefing, and Tasking**

- The SMC or OSC should provide information to SAR facilities on relevant details of the distress and all instructions prior to the conduct of SAR operations. Parent agencies may provide this information by briefing their facilities prior to deployment. Debriefings of the SAR facilities provide valuable information on effectiveness of the search and can influence planning of the next search. SAR facilities and the OSC should be aware of the type of information that the SMC is likely to request. Appendix E provides a sample SAR Briefing and Debriefing Form.
- Masters and pilots-in-command of SAR facilities not designated as search and rescue units should also be contacted by the SMC or OSC for debriefing.

■ **Further Action on Completion of Initial Phase**

- The OSC will normally consider the initial phase to have been completed when, in the absence of further information, searching ships have completed one search of the most probable area.
- If at that stage nothing has been located, it will be necessary for the OSC to consider the most effective method of continuing the search.
- Failure to locate the search object may be due to one or more of the following causes:
 - errors in position owing to navigational inaccuracies or inaccuracy in the distress communications reporting the position. This is especially likely to apply if the position of datum was based on an estimated position using incomplete information
 - an error in drift estimation
 - failure to sight the search object during the search although it was in the search area. This is most likely to occur if the search object is a small craft, a survival craft, or survivors in the water
 - the craft having sunk without a trace. Other than the case of a small ship or craft in rough weather, experience has shown that there are usually some traces, even if only debris or oil patches.

■ ***Navigational Inaccuracies of Searching Ships***

- This is most likely to apply when navigational fixes cannot be obtained. In this situation, the OSC may:
 - re-search the same area, allowing for added drift during the time elapsed since calculating last datum;
 - expand the most probable area, after allowing for added drift, and search the expanded area; or
 - expand the area more in one direction than another, depending on circumstance and information available.
- Determine a new probable area based upon any additional information received.
- Where information is received to indicate that the original datum was grossly inaccurate, determining an entirely new probable area would be advisable.
- A small search object, which is easily missed in the daytime, may become visible at night if it shows lights, flares, or other pyrotechnics.
- The OSC should, therefore, consider using surface craft at night to re-search areas covered by day.
- It is good practice when searching for survivors in small craft, in survival craft, or in the water, to stop the engines occasionally at night and in restricted visibility by day to listen for cries for help.

■ ***Evidence of Distressed Craft Found***

- In some cases, the search may provide evidence of the distressed craft without survivors being found.
- This evidence may provide information for a recalculation of datum and revision of the search area.
- A low-lying, half-sunken loaded ship or aircraft may drift more slowly than a floating survival craft, even if a drogue is used.
- A derelict may drift at a considerable angle off the prevailing wind direction.
- When wreckage is located it usually consists of debris, possibly with an oil slick.
- Should this have come from the distressed craft, survival craft will usually be found downwind from the debris.

Section 3 – On-Scene Co-ordination

- In some cases, however, a ship may have been abandoned some time before sinking, in which case survival craft may be upwind.
- If it is known, or suspected, that survivors are in the water, the area into which they may have been forced by the buffeting of the seas should also be checked.

■ **Manoeuvring Instructions**

- International Regulations for Preventing Collisions at Sea continue to apply fully while carrying out searches.
- Manoeuvring and warning signals will be of particular importance in the circumstances.
- The master of any ship taking part in a search should endeavour to carry out all directions received and have due regard for the safety of the ship and crew.
- To initiate and conduct co-ordinated search patterns, the OSC should transmit a limited number of manoeuvring instructions by the most appropriate means, and in plain language when practicable.
- The text of the message for the initiation of a pattern and subsequent messages relating to its conduct or adjustment should be in standard form. The *International Code of Signals* may serve this purpose and a list of standard text from it follows:

Text or meaning	Code groups
Carry out search pattern _____ starting at _____ hours. Initial course _____ , search speed _____ knots.	FR1
Carry out radar search, ships proceeding in loose line abreast at intervals between ships of _____ miles. Initial course _____ , search speed _____ knots.	FR2
Vessel indicated (<i>call sign or identity signal</i>) is allocated track number _____ .	FR3
Vessel(s) indicated adjust interval between ships to _____ miles.	FR4
Adjust track spacing to _____ miles.	FR5
Search speed will now be _____ knots.	FR6
You should alter course to _____ (at time indicated).	MH
Your should steer course _____ .	MG
Alter course as necessary to next leg of track now (<i>or at time indicated</i>).	FR7

- Other useful signals in the *International Code of Signals*:

Text or meaning	Code groups
I am (or vessel indicated is) in charge of co-ordinating search.	FR
My maximum speed is _____ (number) knots.	SJ
I have no radar.	OI
I have an echo on my radar on bearing _____, distance _____ miles.	ON
I am altering course to _____.	MI
I have sighted survival craft in lat. _____ long. _____ (or bearing _____ distance _____ from me).	GH
I have located (or found) wreckage from the vessel/aircraft in distress (position to be indicated if necessary by lat. _____ and long. _____ or by bearing _____ from specified place and distance _____).	GL
Estimated set and drift of survival craft is _____ degrees and _____ knots.	FP
I wish to communicate by VHF radiotelephony on channel indicated.	YY

- Unless a time is specified in the text, individual ships should proceed as necessary to execute the purpose of the message on receipt.
- Should circumstances require the OSC to direct the ships participating in a pattern to carry out a major alteration of course (anything over 90°) before proceeding to a new area, it would be desirable for the OSC to direct this in two steps.

■ **Survival and Emergency Radio Equipment**

- Aeronautical and maritime survival radio equipment operates on 121.5 MHz, a frequency which can be used for alerting, homing, and on-scene communications, depending on equipment design.
- Ultra-high frequency (UHF).
- 406 MHz is reserved solely as an alerting frequency for ELTs, EPIRBs, and PLBs.
- L-band is used for Inmarsat-E EPIRBs.

Section 3 - On-Scene Co-ordination

- The following frequencies are available for use in vessel and aircraft survival craft, and may be used by portable survival radios on land:
 - 500 kHz (telegraphy)
 - 2182 kHz
 - 121.5 MHz
 - 156.8 MHz.
- Many civil aircraft world-wide, especially operating over ocean areas, carry a 121.5 MHz ELT for alerting and homing.
 - SAR aircraft should be able to home on this frequency to locate survivors
 - an increasing number of ELTs use 406 MHz alerting signals with 121.5 or 243.0 MHz or both for homing signals.
- 406 MHz ELTs and 406 MHz and Inmarsat-E satellite EPIRBs offer coded identities and other advantages which can reduce SAR response time by up to several hours over what would be possible with non-coded ELTs.
- After January 1999:
 - SOLAS ships should have a SART to interact with 9 GHz vessel or aircraft radars for locating survival craft. (SART responses show up as a distinctive line of about 20 equally spaced blips on compatible radar displays, providing a bearing and range to the SART.)
 - ships of 500 gross tons and over will no longer be required by SOLAS to carry radio apparatus for survival craft capable of transmitting and receiving on 500 kHz (telegraphy) and 2182 kHz (telephony), but these frequencies can be expected to still be used
 - ships over 300 gross tons must carry at least two portable survival craft VHF transceivers
 - ships over 500 gross tons must carry at least three portable survival craft VHF transceivers
 - if they operate in the 156–174 MHz band, they will use channel 16 and at least one other channel in this band
 - portable DSC equipment, if capable of operating in the indicated bands, can transmit on at least one of the following frequencies: 2187.5 kHz, 8414.5 kHz, or channel 70 VHF.

- EPIRB signals indicate that a distress exists and facilitate location of survivors during SAR operations. To be effective, searching craft should be able to home on the signals intended for this purpose, or on the alerting frequency itself (which will be non-continuous if it is 406 MHz).

Conclusion of Search

■ Search Unsuccessful

- The OSC should continue the search until all reasonable hope of rescuing survivors has passed.
- The OSC may need to decide whether to terminate an unsuccessful search (do in consultation with the SMC when practicable). For this determination, factors to consider include the following:
 - probability that survivors, if alive, were in the search area
 - probability of detection of the search object, if it were in the areas searched
 - time remaining that search facilities can remain on-scene
 - probability that survivors might still be alive.
- The following diagrams illustrate the probability of survival under various temperature, wind, and sea conditions:

Estimated wind speed (knots)	Actual air temperature (°C/°F)					
	10/50	0/32	-12/10	-23/-9	-35/-31	-45/-49
0	Little danger for properly dressed persons			Increased danger of freezing of exposed flesh		Great danger of freezing of exposed flesh
10						
20	Little danger for properly dressed persons			Increased danger of freezing of exposed flesh		Great danger of freezing of exposed flesh
30						
40 or more	Little danger for properly dressed persons			Increased danger of freezing of exposed flesh		Great danger of freezing of exposed flesh

Effect of wind on exposed persons

Section 3 – On-Scene Co-ordination

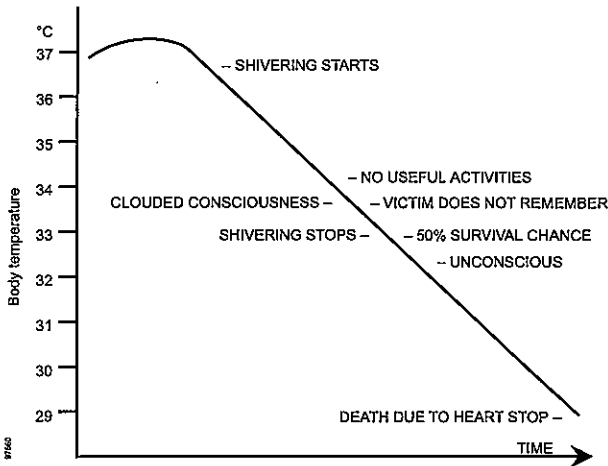

Symptoms in hypothermia (lowered body temperature)

Guide to survival time for persons without special protective clothing in water of various temperatures

Temperature (°C)	Expected time of survival
Less than 2	Less than $\frac{3}{4}$ hour
2 to 4	Less than $1\frac{1}{2}$ hours
4 to 10	Less than 3 hours
10 to 15	Less than 6 hours
15 to 20	Less than 12 hours
Over 20	Indefinite (depends on fatigue)

- The OSC, after consultation with other assisting craft and land-based authorities, should take the following action:

Ocean Incident

- terminate active search
- advise assisting craft to proceed on passage and inform the land-based authority
- send a message to all ships in the area asking them to continue to keep a look-out

Coastal Incident

- consult with land-based authorities about the termination of search.

■ ***Search Successful***

- Once the distressed craft or survivors have been sighted, the OSC should assess the best method for the rescue and direct the most suitably equipped craft to the scene. See Section 2, Rescue Function, for discussion on rescue by various types of SAR facilities.
- Ensure that all survivors are accounted for.
- Survivors should be questioned concerning:
 - the ship or aircraft in distress, number of persons on board
 - whether other survivors or survival craft have been seen
 - this information should be promptly relayed to the SMC.
- When all rescuing action has been effected, the OSC should immediately inform all search facilities that the search has been terminated.
- The OSC should inform the SMC of the conclusion of the search and give the following details:
 - names and destinations of ships with survivors, and identities and numbers of survivors in each
 - physical condition of survivors
 - whether medical aid is needed
 - the state of the distressed craft and whether it is a hazard to navigation.



Section 4 – On-Board Emergencies

Contents

General Advice..... 4-1

Distress Alert Notification

 Distress Signals

 Spoken Emergency Signals
 and Procedural Words..... 4-1

 Methods of Alert

 Distress Alert from a Vessel..... 4-3

 Distress Alert from an Aircraft..... 4-3

 EPIRBs and ELTs..... 4-4

 Additional Equipment..... 4-5

 Vessel Distress Message..... 4-5

Cancellation of Distress Message..... 4-8

MEDICO..... 4-8

Medical Evacuation (MEDEVAC)..... 4-9

 Evacuation by Helicopter..... 4-10

 Vessel Preparation..... 4-10

 Shipboard Safety Checklist..... 4-11

 Other Considerations..... 4-12

Person Overboard

 Three Situations..... 4-13

 Ship Manoeuvres..... 4-13

 Initial Action..... 4-13

 Standard Methods of Recovery..... 4-14

Ship Emergencies at Sea

Shipboard Fire	4-16
Grounding	4-16
Hull Damages	4-16
Abandoning Ship.....	4-17
Medical Emergencies	4-17
Unlawful Acts	
Pirates and Armed Robbers.....	4-17

Aircraft Emergencies

Aircraft Distress Message.....	4-19
Distress	4-19
Urgency.....	4-19
Aircraft Pilot Distress Message Checklist.....	4-19
Transmission of the Distress Message.....	4-20
Vessel-Aircraft Communications.....	4-20
2182 kHz	4-21
4125 kHz	4-21
3023 and 5680 kHz	4-21
121.5 MHz AM.....	4-21
123.1 MHz AM.....	4-22
156.8 MHz FM	4-22

In-flight Emergencies – General Information

Unlawful Interference	4-22
Low on Fuel	4-22
Mechanical Difficulties.....	4-22
Loss of Communications.....	4-22
Forced Landing.....	4-22
Aircraft Ditching.....	4-23
Emergency Equipment.....	4-29

Section 4 – On-Board Emergencies

General Advice

Pilots-in-command and masters should not delay notifying the SAR system if a problem is, or may be, developing which could involve need for assistance. This allows the SAR system to carry out preliminary and contingency planning that could make the critical difference if the situation worsens.

Distress Alert Notification

■ *Distress Signals*

Spoken Emergency Signals and Procedural Words

- Three spoken emergency signals are used by aircraft and vessels:

Distress signal

- **MAYDAY** (pronounced M'AIDER) is used to indicate that a mobile craft is in imminent danger and requests immediate assistance – for example, when a vessel has a person overboard and a master considers that further help is necessary
- has priority over all other communications

Urgency signal

- **PAN-PAN** (pronounced PAHN-PAHN) is used when the safety of a mobile craft is in jeopardy
- The urgency signal **PAN-PAN** should be used when an unsafe situation exists that may eventually involve a need for assistance
- has priority over all but distress traffic

Safety signal

- **SECURITY** (pronounced SAY CURITAY) is used for messages concerning safety of navigation or giving important meteorological warnings.

Section 4 - On-Board Emergencies

- Any message headed by one of these signals has precedence over routine messages.
 - The signal is usually repeated three times at the beginning of the message.
- A pilot-in-command or a master in distress situation should declare a distress condition using the MAYDAY signal.
- Basic spoken radio procedural words which SAR personnel should understand and use are as follows:
 - AFFIRMATIVE means that what a person has transmitted is correct
 - BREAK is used to separate portions of a message or one message from another
 - FIGURES is spoken just before numbers are given in a message
 - I SPELL is used just before a phonetic spelling, such as of a proper name
 - NEGATIVE means “no”
 - OUT indicates the end of a transmission when no reply is expected or required
 - OVER indicates the end of a transmission when an immediate reply is expected
 - ROGER means “I have received your transmission satisfactorily”
 - SILENCE is said three times and means “cease all transmissions immediately”
 - SILENCE FINI (pronounced SEE LONSS FEE NEE) means “silence is lifted”, and is used to signify the end of the emergency and resumption of normal traffic
 - THIS IS is said before the station name or call sign which immediately follows
 - WAIT means “I must pause for a few seconds; stand by for further transmission”.
- For a more detailed listing of procedural words to use, refer to the *International Code of Signals*.

Methods of Alert

■ *Distress Alert from a Vessel*

- Use any one or more of the following international maritime distress frequencies to transmit a distress alert:
 - 500 kHz (radio telegraphy), the use of which will be phased out when GMDSS is implemented
 - 2182 kHz (radiotelephony)
 - 156.8 MHz FM (VHF, channel 16)
 - any distress transmissions on the frequency 500 kHz or 2182 kHz could be preceded by the appropriate alarm signal
 - in remote oceans areas, the distress call should also be transmitted on a ship-to-shore HF circuit to a CRS, especially when distress calls on 500 kHz, 2182 kHz, or channel 16 are not replied to by other stations.
- Should there be doubt concerning the reception of the distress message, it should also be transmitted on any frequency available on which attention might be attracted, such as an inter-ship frequency which may be in use in local areas.
- Before changing frequency, however, adequate time should be allowed for reply.
- In the event of failure of the ship's radio station, it may be possible to transmit a message using portable equipment, provided for use in survival craft.

■ *Distress Alert from an Aircraft*

- The aircraft would normally notify an ATS unit, which should notify the RCC.
- Use 121.5 MHz if there is no response on the assigned *en-route* frequency:
 - transmit blind
 - set transponder to 7700 for distress.
- An aircraft in distress may use any means at its disposal to attract attention, make known its position, and obtain help.

■ **EPIRBs and ELTs**

- EPIRBs and ELTs are another means of alerting. They are intended for alerting when other available means of alerting are inadequate.
- An EPIRB transmits a signal that alerts SAR authorities and allows rescue facilities to home in on the distressed vessel.
 - activated automatically upon exposure to the sea, or manually
 - types of maritime satellite EPIRBs:
 - 406 MHz satellite EPIRBs whose signals are relayed via Cospas-Sarsat satellites
 - Inmarsat-E EPIRBs whose signals are relayed via Inmarsat satellites
 - non-satellite VHF EPIRBs on channel 70, used close to shore in lieu of satellite EPIRBs where receiving stations are available.
- Most civil aircraft carry one of two types of ELT to alert SAR authorities to a distress situation.
 - 406 MHz satellite ELT intended for use with Cospas-Sarsat satellites
 - 121.5 MHz ELT intended to be heard by high-flying aircraft.
- Cospas-Sarsat calculates position information for EPIRBs and ELTs.
- Most ELTs and EPIRBs provide homing signals on 121.5 MHz; some also use 243 MHz, and some EPIRBs may also integrate SARTs into their designs.
- Most EPIRBs and all ELTs are designed to activate automatically when a vessel sinks or an aircraft crashes (EPIRB alerts tell whether the beacon was activated automatically or manually).
- Some ELTs and EPIRBs may also have integral GPS capabilities.
- Inmarsat-E EPIRBs transmit messages via Inmarsat geostationary satellites and CESs to RCCs. These beacons have registered coded signal identities.
- Position information from Inmarsat-E EPIRBs is derived either from integral equipment such as GPS, or via interfaces with shipboard navigation equipment (positions from shipboard equipment cannot be updated after the EPIRB floats free).

- Inmarsat-E EPIRBs operate only within Inmarsat's coverage area, generally between 70° latitude north and south.
- It is recommended that an activated EPIRB, even if inadvertently activated (false alarm), be kept on until the RCC is informed.
 - This enables the RCC to work with a more accurate position and identification, allowing resolution of the alert without dispatching SAR facilities needlessly
 - Immediately attempt to notify the RCC by other means that the alert is false.

■ **Additional Equipment**

- SOLAS ship requirements include the following:
 - two-way VHF radio-telephone apparatus and survival craft radar transponders to be placed on each side of the vessel, in a position ready to be taken on board a survival craft
 - the SART, after being switched on manually, is activated automatically by receiving radar pulses
 - it automatically sends out a series of pulses which are displayed on the radar screen as a series of elongated pips, similar to a radar responder beacon (racon) pip.

■ **Vessel Distress Message**

- Important components of the distress message include:
 - identification of the vessel
 - position
 - nature of distress and kind of assistance required
 - weather in immediate vicinity, wind direction, sea and swell, visibility
 - time of abandoning ship
 - number of crew remaining on board
 - number and type of survival craft launched
 - emergency location aids in survival craft or in the sea
 - number of seriously injured.
- Include as much of the above information as practical in the initial distress message.

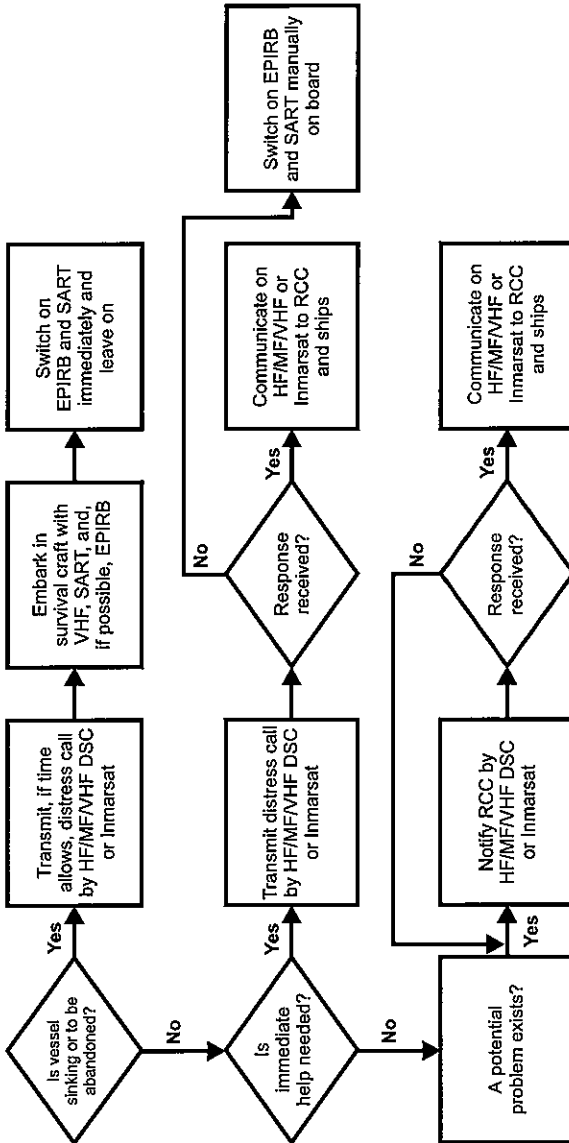

RADIO DISTRESS COMMUNICATIONS	
Digital Selective Calling (DSC)	Radiotelex
VHF Channel 70	2175.4 kHz
MF 2187.5 kHz	4177.5 kHz
HF4 4207.5 kHz	6288 kHz
HF6 6312 kHz	8376.5 kHz
HF8 8414.5 kHz	12520 kHz
HF12 12577 kHz	16695 kHz
HF16 16804.5 kHz	
	Channel 16
	2182 kHz
	4125 kHz
	6215 kHz
	8291 kHz
	12290 kHz
	16420 kHz

1. EPIRB should float free and activate automatically if it cannot be taken into survival craft.
2. Where necessary, ships should use any appropriate means to alert other ships.
3. Nothing above is intended to preclude the use of any and all available means of distress alerting.

1924

GMDSS operating guidance for masters of ships in distress situation

Section 4 - On-Board Emergencies

- The timing of subsequent transmissions will be governed by circumstances.
- In general, if time allows, a series of short messages will be preferable to one or two long ones.
- Visual international distress signals are shown below. Section 3 provides more information.



A red parachute flare



Flames

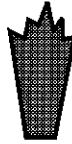

Red flare

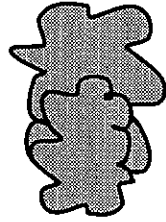

Yellow smoke



The flags "N.C."

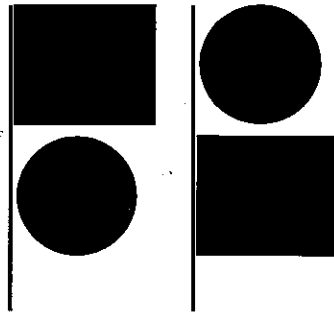

A square flag having above or below it a ball

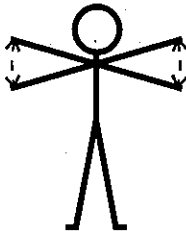

Slowly and repeatedly raising and lowering the arms – outstretched



S.O.S. by light or sound

97662

Cancellation of Distress Message

- Cancellation should occur as soon as the distressed craft has been recovered or when the assistance of SAR facilities is no longer required.
- Any false alert, including by inadvertent human error, should be cancelled so that SAR authorities do not needlessly respond.

MEDICO

- MEDICO messages request or transmit medical advice from and to a vessel at sea.
- Each MEDICO message may be addressed to RCCs or communications facilities from ships at sea.
- The messages should be prefixed “DHMEDICO” so that communications personnel know to handle them as MEDICO messages.
- The ITU *List of Radiodetermination and Special Service Stations* lists commercial and Government radio stations which provide free medical message service to ships.
 - these messages are normally delivered only to hospitals or other facilities with which SAR authorities or the communications facility has made prior arrangements.
- SAR services may provide medical advice either with their own doctors, or via arrangements with doctors outside the SAR organization.
- There are several commercial enterprises which provide international subscription and pay-per-use medical advice to vessels at sea.
 - the best known medical advisory service is Centro Internazionale Radio-Medico (CIRM)
 - headquarters in Rome, Italy
 - CIRM maintains doctors on 24-hour availability
 - provides free medical advice by radio to ships around the world
 - to obtain more information about CIRM services:
 - telephone 06/5923331-2
 - facsimile 06/5923333
 - telex 612068 CIRM I.

- Replies to messages should indicate the medical facility which provided the medical information.

Medical Evacuation (MEDEVAC)

- If medical evacuations are being considered, the benefits must be weighed against the inherent dangers of such operations to both the person needing assistance and to the rescue personnel.
- When medical assistance is required, information as indicated below should be sent to the RCC. Other information may be necessary in certain cases.
 - name of the vessel and radio call sign
 - position of the vessel, port of destination
 - estimated time of arrival, course, and speed
 - patient's name, age, gender, nationality, and language
 - patient's respiration, pulse rate, temperature, and blood pressure
 - location of pain
 - nature of illness or injury, including apparent cause and related history
 - symptoms
 - type, time, form, and amounts of all medications given
 - time of last food consumption
 - ability of patient to eat, drink, walk, or be moved
 - with accident cases, how the accident occurred
 - whether the vessel has a medicine chest, and whether a physician or other medically trained person is aboard
 - whether a suitable clear area is available for helicopter winch operations or landings
 - name, address and phone number of vessel's agent
 - last port of call, next port of call, and ETA to next port of call
 - communications and homing signal available
 - additional pertinent remarks.
- The final decision about whether it is safe to conduct an evacuation remains ultimately with the person in command of the rescue facility tasked with conducting the evacuation.

■ **Evacuation by Helicopter**

- When arranging for the evacuation of a patient by helicopter, the following points should be considered.
 - requesting helicopter assistance
 - arrange a rendezvous position as soon as possible if the vessel is beyond helicopter range and must divert
 - give as much medical information as possible, particularly about the patient's mobility
 - advise immediately of any changes in the condition of the patient
 - preparation of patient before the helicopter arrives
 - move the patient as close to the helicopter pick-up area as the patient's condition permits
 - ensure the patient is tagged to show details of any medication which has been administered
 - prepare the patient's seaman's papers, passport, medical record, and other necessary documents in a package ready for transfer with the patient
 - ensure that personnel are prepared as necessary to move the patient to the special stretcher (lowered by the helicopter) as quickly as possible
 - the patient should be strapped in the stretcher face-up, in a lifejacket if condition permits.

■ **Vessel Preparation**

- The following information should be exchanged between the helicopter and the vessel to prepare for helicopter operations:
 - position of the ship
 - course and speed to the rendezvous position,
 - local weather situation
 - how to identify the ship from the air (such as flags, orange smoke signals, spotlights, or daylight signalling lamps).
- The following checklist can help the ship's deck officer prior to helicopter-ship operations. The checklist was created for a large merchant vessel but provides information useful for any size vessel.

Shipboard Safety Checklist

To be checked by officer in charge

General

- Have all loose objects within and adjacent to the operating area been secured or removed?
- Have all aerials, standing or running gear above the operating area been secured or removed?
- Has a pennant or windsock been hoisted where it can be clearly seen by the helicopter pilot?
- Has the officer of the watch been consulted about the ship's readiness?
- Does the leader of the deck party have a portable radio transceiver (walkie talkie) for communicating with the bridge?
- Are the fire pumps running and is there adequate pressure on deck?
- Are fire hoses ready (hoses should be near to but clear of the operating area)?
- Are foam hoses, monitors, and portable foam equipment ready?
- Are dry powder fire extinguishers available and ready for use?
- Is the deck party complete, correctly dressed, and in position?
- Are the fire hoses and foam nozzles pointing away from the operating area in case of inadvertent discharge?
- Has a rescue party been detailed?
- Is a person-overboard rescue boat ready for lowering?
- Are the following items of equipment to hand?

Large axe	Crowbar
Wire cutters	Red emergency signal/torch
Marshalling batons (at night)	First-aid equipment
- Has the correct lighting (including special navigation lights) been switched on prior to night operations and not directed towards the helicopter?
- Is the deck party ready, wearing brightly coloured waistcoats and protective helmets, and are all passengers clear of the operating area?
- Has the hook handler been equipped with helmet, strong rubber gloves and rubber-soled shoes to avoid the danger of static discharge?
- Is access to and egress from the operating area clear?
- Has the radar been secured or placed in standby mode just before the helicopter arrives?

Section 4 - On-Board Emergencies

Landing On

- Is the deck party aware that a landing is to be made?
- Is the operating area free of heavy spray or seas on deck?
- Have side rails and, where necessary, awnings, stanchions, and other obstructions been lowered or removed?
- Where applicable, have portable pipes been removed and have the remaining apex ends been blanked off?
- Are rope messengers to hand for securing the helicopter, if necessary? (Note: only the helicopter pilot may decide whether or not to secure the helicopter.)
- Have all personnel been warned to keep clear of rotors and exhausts?

Tankers: Additional Items

- Ships not fitted with an inert gas system:* Has pressure been released from tanks within 30 minutes of commencement of helicopter operations?
- Ships fitted with an inert gas system:* Has pressure in cargo tanks been reduced to slight positive pressure?
- All tankers:* Have all tank openings been secured following venting operations?

Bulk Carriers and Combination Carriers: Additional Items

- Has surface ventilation to dry bulk cargoes ceased, and have all hatch openings been fully battened down prior to helicopter operations?

Gas Carriers: Additional Items

- Have all precautions been taken to prevent vapour emission?

■ **Other Considerations**

- Vessels which are not well suited for helicopter landing operations (due to their size, design or nature of their cargoes) should carefully consider how to best remove or deliver those people or equipment in an emergency.
- Emergency procedures might consist of evacuation of an injured person or delivering a doctor on board by winching.
- For further information regarding helicopter operations, vessel preparations, and safety briefing, see section 3.

Person Overboard

■ Three Situations

● *Immediate action*

- The person overboard is noticed from the bridge and action is taken immediately.

● *Delayed action*

- The person is reported to the bridge by an eyewitness and action is initiated with some delay.

● *Person-missing action*

- The person is reported to the bridge as missing.

■ Ship Manoeuvres

- When the possibility exists that a person has fallen overboard, the crew must attempt to recover the individual as soon as possible.

- Some factors that will affect the speed of recovery include:

- ship's manoeuvring characteristics
- wind direction and sea state
- crew's experience and level of training
- capability of the engine plant
- location of the incident
- visibility level
- recovery technique
- possibility of having other vessels assist.

■ Initial Action

- Throw a life-ring over the side as close to the person as possible.
- Sound three prolonged blast of ship's whistle, hail "Person Overboard".
- Commence recovery manoeuvre as indicated below.
- Note position, wind speed & direction, time.
- Inform master of vessel and engine-room.

Section 4 – On-Board Emergencies

- Post look-outs to keep the person in sight.
- Set off dye marker or smoke flare.
- Inform radio operator, keep updated on position.
- Stand by the engines.
- Prepare lifeboat for possible launching.
- Distribute portable VHF radios for communication between bridge, deck, and lifeboat.
- Rig pilot ladder to assist in recovery.

■ **Standard Methods of Recovery**

- Williamson turn
 - makes good original track line
 - good in reduced visibility
 - simple
 - takes the ship farther away from the scene of the incident
 - slow procedure

Williamson turn

Rudder hard over (in an "immediate action" situation, only to the side of the casualty).

After deviation from the original course by 60°, rudder hard over to the opposite side.

When heading 20° short of opposite course, rudder to midship position and ship to be turned to opposite course.

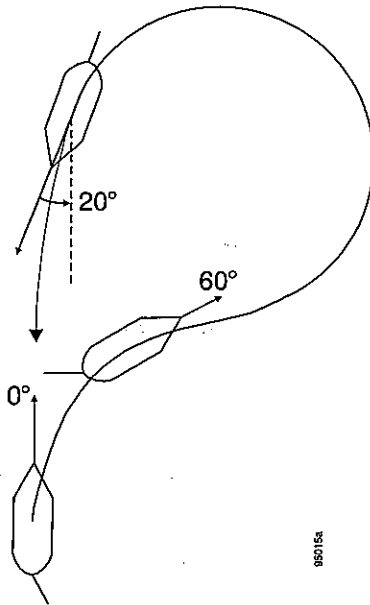

880156

- One turn ("Single turn, Anderson turn")
 - fastest recovery method
 - good for ships with tight turning characteristics
 - used most by ships with considerable power
 - very difficult for a single-screw vessel
 - difficult because approach to person is not straight

Single turn (270° manoeuvre)

Rudder hard over (in an "immediate action" situation, only to the side of the casualty).

After deviation from the original course by 250°, rudder to midship position and stopping manoeuvre to be initiated.

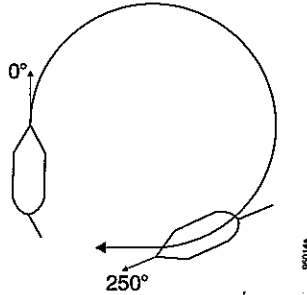

- Scharnov turn
 - will take vessel back into her wake
 - less distance is covered, saving time
 - cannot be carried out effectively unless the time elapsed between occurrence of the incident and the commencement of the manoeuvre is known

Scharnov turn

(Not to be used in an "immediate action" situation.)

Rudder hard over.

After deviation from the original course by 240°, rudder hard over to the opposite side.

When heading 20° short of opposite course, rudder to midship position so that ship will turn to opposite course.

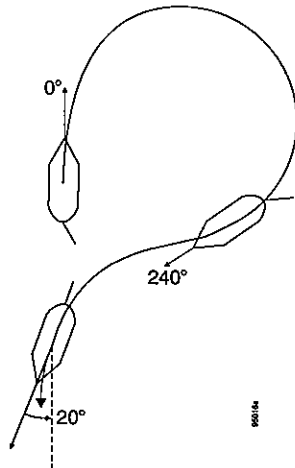

Ship Emergencies at Sea

- Some emergencies at sea consist of:

Shipboard Fire

- sound fire alarm
- report location of fire
- assess fire
 - determine the class of fire
 - determine appropriate extinguishing agent
 - determine appropriate method of attack
 - determine how to prevent the spread of the fire
 - determine the required personnel and fire-fighting assignments
 - establish proper communications between bridge and location of fire
 - begin procedures for attacking the fire
 - continue until fire is extinguished
- if assistance is required, transmit distress call and message

Grounding

- check for hull damages
- if assistance is required, transmit a PAN-PAN urgency signal
- determine which way deep water lies
- determine if wind and sea are carrying the vessel harder aground
- lessen the draught of the vessel
- put engines astern to back away
- if extrication is impossible until assistance arrives or change of tide, minimize hull damage and water intake

Hull Damages

- identify location of incoming water
- cut off all electrical power running through area
- shore up area to stem water flow
- check bilge pump for operation
- check auxiliary pumps for back-up operation if needed
- if necessary, abandon vessel as a last resort

Abandoning Ship

- abandon ship only as last resort
- transmit distress call and message
- wear lifejackets, have adequate clothing.
- in waters below 16°C (60°F), put on immersion suits
- have crew members stand by lifeboat or liferaft and prepare to launch
- make sure sea painter is attached to vessel
- load crew and launch
- keep lifeboat or liferaft tethered to vessel as long as possible

Medical Emergencies

- conduct assessment of victim for primary medical treatment
- attend to treatment as best as possible with on-board facilities and medications
- see previous discussion on MEDICO and MEDEVAC
- if medical evacuation is required, alert proper authorities
- prepare patient for evacuation
- gather appropriate paperwork and attach to patient.

■ *Unlawful Acts*

Pirates and Armed Robbers

- There is a special signal for use by a vessel under attack or threat of attack from pirates or armed robbers.
- “Piracy/armed robbery attack” is a category of distress message for all classes of DSC equipment and Inmarsat has added a piracy message to the Inmarsat-C menu for the GMDSS.
 - for their own safety, vessels may have to covertly send out a “piracy/armed robbery attack” message.
- When the RCC becomes aware of such a situation, it will advise appropriate agencies.
- If the vessel covertly sends a message, care will be taken regarding any communications sent back to the vessel so as not to warn the pirates.

Section 4 – On-Board Emergencies

- The two distinct phases to an attack by pirates or armed robbers are:
 - pirates are detected by shipboard personnel prior to boarding of the vessel
 - pirates board unnoticed, taking hostages and making threats of violence or death to the vessel's crew.
- Pirates normally order the vessel not to make any radio transmissions, with further threats of violence.

Pirates detected prior to boarding of the vessel

- Providing the vessel has not been ordered by the pirates to maintain radio silence, contact should immediately be made with vessels in the vicinity and shore authorities by sending a "piracy/armed robbery attack" message through Inmarsat or on an available DSC or other distress and safety frequency.

Pirates board unnoticed

- A vessel should comply with any order by pirates or armed robbers not to make any form of transmission informing shore authorities of the attack. Pirates may carry equipment capable of detecting terrestrial radio signals.
 - a recommended alternative in this scenario is for the alarm signal to be automatically made through satellite so as not to be detected by the pirates
 - the alarm signal should be made through Inmarsat by using the Inmarsat-C "piracy/armed robbery attack" message along with the vessel's current position.
- This message should be activated by means of concealed push buttons located in at least three separate locations on the vessel
 - wheelhouse
 - master's cabin
 - engine-room.
- Activation of the push button should result in the satellite terminal automatically selecting and transmitting the attack message to the appropriate shore authority.

- To avoid false alerts there should be a coded sequence of operation of the push button which will require deliberate action to activate it. This system will:
 - leave the pirates unaware that a message has been transmitted
 - provide early warning to shore authorities that an attack is in progress and may deter future attacks.

Aircraft Emergencies

- For in-flight emergencies, follow the guidance provided in the flight operations manual for the particular aircraft being flown. If that manual is not available, the following general information should be helpful.

■ Aircraft Distress Message

- An emergency can be either a DISTRESS or an URGENCY condition.

Distress

- begin initial communication with the word "MAYDAY", repeated three times

Urgency

- begin initial communication with the word "PAN-PAN", repeated three times.

- Specific procedures in handling emergency situations cannot be prescribed due to the variety of possible emergency situations.
 - the flight operations manual for the specific type of aircraft is the best source of guidance and should be carried on board.

■ Aircraft Pilot Distress Message Checklist

- When reporting an in-flight emergency, the pilot-in-command should expect the ATS unit to request the following information:
 - aircraft identification and type
 - nature of the emergency
 - pilot's desires or intentions
 - pilot should also include:
 - aircraft altitude
 - fuel remaining, in hours and minutes
 - pilot-reported weather

Section 4 – On-Board Emergencies

- pilot capability for instrument flight rules (IFR) flight
- time and place of last known position
- heading since last known position
- airspeed
- navigation equipment capability
- NAVAID signals received
- visible landmarks
- aircraft colour
- number of persons on board
- point of departure and destination
- emergency equipment on board.

■ **Transmission of the Distress Message**

- When an aircraft transmits a distress message by radio, the first transmission is generally made on the designated air-ground *en-route* frequency in use between the aircraft and an ATS unit.
 - although 121.5 MHz and 243.0 MHz are emergency frequencies, the aircraft will usually be kept on the initial contact frequency
 - change frequencies only when there is a valid reason.
- In an emergency, the aircraft may use any other available frequency to establish contact with any land, mobile, or DF station.
- SAR organizations ordinarily will inform merchant ships of aircraft emergencies at sea.

■ **Vessel-Aircraft Communications**

- Civil vessels and aircraft may need to communicate with each other if either is in an emergency situation or communicating with SAR facilities.
- Since these occasions may be infrequent, civil aircraft usually do not carry additional equipment for these purposes; incompatible equipment may make communications difficult.
- The aeronautical mobile service uses amplitude modulation (AM) for VHF telephony while the maritime mobile service uses frequency modulation (FM).
- Except for SRUs, vessels normally cannot communicate on 3023 and 5680 kHz, or on 121.5 and 123.1 MHz.

- The following frequencies may be used for safety communications between vessels and aircraft when compatible equipment is available:

2182 kHz

- many vessels, especially fishing vessels, and nearly all ships, are equipped to use 2182 kHz
 - some transport aircraft can transmit on 2182 kHz, and aircraft designated for maritime SAR operations are required to carry this frequency
 - aircraft may have difficulty calling up vessels on 2182 kHz, as vessels normally guard this frequency through automatic means, and are alerted when the radiotelephone alarm signal is transmitted

4125 kHz

- this frequency may be used by aircraft to communicate with ships for distress and safety purposes
 - all ships may not carry this frequency
 - if an aircraft needs help from a ship, SAR authorities can notify ships in the vicinity of the situation and ask them, if practicable, to set up watch on frequency 4125 kHz

3023 and 5680 kHz

- these are HF on-scene radiotelephony frequencies for SAR
 - designated SAR aircraft and most civil aircraft carrying HF equipment can operate on these frequencies
 - they may also be used by vessels and CRSs engaged in co-ordinated SAR operations

121.5 MHz AM

- this is the international aeronautical distress frequency
 - all designated SAR aircraft and civil aircraft carry equipment operating on 121.5 MHz
 - it may also be used by ground stations or maritime craft for safety purposes
 - all aircraft should guard this frequency, flight-deck duties and equipment limitations permitting

123.1 MHz AM

- this is the aeronautical on-scene frequency which may be jointly used by aircraft and vessels engaged in SAR operations

156.8 MHz FM

- this is the VHF maritime distress frequency (channel 16) carried by most ships and other maritime craft
 - civil aircraft do not normally carry radios which can use this frequency, but some aircraft which regularly fly over water do, usually in portable equipment
 - designated SAR aircraft should be able to use this frequency to communicate with vessels in distress and assisting vessels.
- Once alerted, RCCs can often help aircraft make arrangements for direct communications with vessels, or provide a message relay.

■ **In-flight Emergencies – General Information**

- Some in-flight emergencies consist of:

Unlawful Interference

- If able, set transponder to 7500 for unlawful interference.

Low on Fuel

- Establish the most economical airspeed; if the engine(s) fail, maintain the best glide airspeed.
- Communicate the situation, position, and intentions to the appropriate ATS unit, using 121.5 MHz if no other frequency is available.
- It is safer to land or ditch under power and before fuel is exhausted.

Mechanical Difficulties

- If able, communicate the situation, position, and intentions to the appropriate ATS unit, using 121.5 MHz if no other frequency is available.
- Land as soon as practical.

Loss of Communications

- Set the transponder to 7600 for communications failure.
- Use visual signals in section 2, under Search Function.

Forced Landing

- Set the transponder to 7700 for distress.
- Notify ATS of situation, position, and intentions.

- Choose a suitable landing spot.
- Ensure that seat belts and harnesses are properly secured.
- *With power:*
 - overfly the intended landing site at low speed and altitude, looking for obstructions and verifying wind direction
 - climb to a normal pattern altitude
 - make a normal approach, using full flaps and landing techniques for short or soft fields
 - have passengers brace for impact
 - keep the landing gear up for rough fields and water landings
 - switch fuel and electrical power off when landing is assured
 - evacuate the aircraft immediately and remain clear until danger of fire has passed
 - administer first aid to injured crew and passengers as needed
 - manually activate the ELT.
- *Without power:*
 - make a normal approach, using full flaps and landing techniques for short or soft fields
 - have passengers brace for impact
 - keep the landing gear up for rough fields and water landings
 - switch fuel and electrical power off once the flaps and gear (if applicable) are down
 - evacuate the aircraft immediately and remain clear until danger of fire has passed
 - administer first aid to injured crew and passengers as needed
 - manually activate the ELT.

Aircraft Ditching

- Set the transponder to 7700 for distress.
- Notify ATS of situation, position, and ditching intentions
 - normally this will be done on the *en-route* air traffic control frequency or 121.5/243.0 MHz
 - if two-way communications are not established, transmit in the blind
 - if the aircraft is equipped with HF radio, ask ATS to have SAR authorities alert ships in the vicinity and have those ships attempt communications with the aircraft on 4125 kHz.

Section 4 – On-Board Emergencies

- If bailing out is an option, determine whether this would be safer than ditching.
 - military fighter aircraft, due to their high landing speed and small size, often react violently to ditching
 - military bombers, because of their relatively weak bottom due to large bomb-bay doors, can break apart under the forces encountered in ditching
 - for both of these aircraft types, it usually is better to bail out rather than ditch
 - most other types of aircraft have been ditched successfully
 - ditching performance is best in pressurized, low-wing aircraft without large underslung engine nacelles or long afterbodies.
- Determine the primary and secondary swell directions.
 - primary swell will be visible during day visual meteorological conditions (VMC) from an altitude of 2000 feet or higher
 - swells are generated by distant weather systems and do not break
 - the primary swell system will appear as a definite pattern or differences in light intensity on the surface
 - watch the pattern for a few moments, the direction of motion can be determined
 - at night or under IMC, this information may be available from surface ships in the area
 - the secondary swell system, if present, may not be visible until the altitude is between 1500 and 800 feet.
- Determine surface wind direction and speed.
 - examine local wind effects on the water
 - whitecaps fall forward with the wind, but are overrun by waves, thus producing the illusion that the foam is sliding backward. Plan to land in the same direction that the whitecaps are moving unless the swells are large
 - wind velocity can be accurately estimated by noting the appearance of the whitecaps, foam, and wind streaks
 - the Beaufort scale is provided at the end of this discussion for wind velocity and wave heights.

- Verify wind and swell analysis.
 - when flying at low altitude above the water the seas will appear to be steep, fast, and rough when heading into them
 - when flying down or parallel to the seas, the surface appears to be more calm.
- Jettison cargo and fuel, but retain sufficient fuel for landing under power.
- Ensure that seat belts and harnesses are properly secured.
- Determine the best heading for ditching.
 - The figure below shows a landing parallel with the swell. This is the best ditching heading; landing on the top or back side of the swell is preferable.

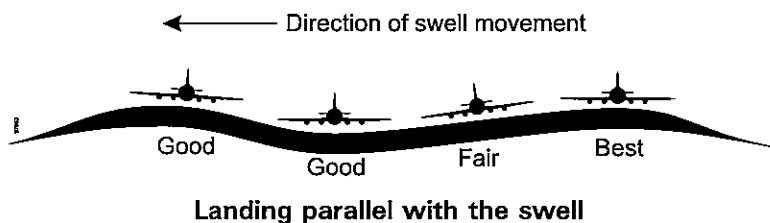

- the best ditching heading usually is parallel to the primary swell system and down the secondary swell system
- the next best choice is parallel to the secondary swell system and down the primary swell system
- the choice between these two options is determined by which will give the greatest headwind component
- try to land with the wind on the opposite side to the passenger door; this more-sheltered side may make opening the door and subsequent exit by passengers easier.
- Never land into the face (or within 35° of the face) of a primary swell unless the surface winds are an appreciable percentage of the aircraft stalling speed in the ditching configuration.

Winds 0-25 knots

- ignore the crosswind component and land parallel to the primary swell, using the heading that has the greatest headwind component

Section 4 – On-Board Emergencies

- if a pronounced secondary swell exists, it may be desirable to land down the secondary system and accept some tailwind component

Winds above 25 knots

- it may be necessary to select a heading neither parallel to the swell (since the crosswind component may make for unacceptable control at slow airspeeds) nor into the wind (because the ground-speed reduction due to the headwind will not compensate for the disadvantage of landing into the swell)
- a heading at an angle into the wind and primary swell is indicated, with more of a crosswind component accepted the higher the swells and more of a headwind component taken the higher the winds with respect to the aircraft stalling speed
- when landing parallel to a swell system, it is best to land on the crest; it is acceptable to land on the back-side or in the trough
- landing on the face of the swell should be avoided
- if forced to land into a swell, touchdown should be just after passage of the crest.



Landing on the back side of a swell

- Turn to the ditching heading and begin letdown.
 - flaps should be fully extended
 - the landing gear should be left retracted.
- When at a low altitude, slow to touchdown speed, 5 to 10 knots above the stall.
- Use power to maintain a minimal (no more than 300 feet per minute) rate of descent and approximate 10° nose-up attitude.
 - the kinetic energy to be dissipated, and resulting deceleration, increase with the SQUARE of the velocity at touchdown
 - when over smooth water or at night it is very easy to misjudge the height over the water. This technique minimizes the chance of

misjudging the altitude, stalling the aircraft, and entering the water in a disastrous nose-down attitude

- the proper use of power on the approach is extremely important
- if power is available on one side only, a little power should be used to flatten the approach; a balance will need to be achieved between the need to impact the water as slowly as possible and the loss of control that can occur with sudden application of unbalanced power at an airspeed near the stall.
- Pick a touchdown spot.
 - the pilot should observe the sea surface ahead
 - shadows and whitecaps close together indicate that the seas are short and rough
 - touchdown in those areas should be avoided
 - touchdown should be in an area (only about 150 m is needed) where the shadows and whitecaps are not so numerous.
- Cut the power and brace for impact.
 - maintain airspeed at 5 to 10 knots above the stall; do NOT let the aircraft stall; do not flare the landing
 - if necessary to keep the proper nose-up attitude, keep power until the tail touches the surface
 - keep the wings level.
- Evacuate the aircraft as rapidly as possible after all motion has stopped.
 - passengers should remain strapped into their seats until the inrush of water, if any, has subsided, in order to avoid being swept around the cabin
 - helicopters are prone to roll inverted except in very calm water, even if equipped with flotation devices
 - in order to avoid disorientation, occupants should identify and hold onto a reference until ready to exit the aircraft
 - lifejackets must not be inflated until clear of the aircraft.

Section 4 - On-Board Emergencies

Beaufort scale

Beaufort number	Wind velocity (knots)	Sea indications	Height of waves (metres/feet)
0		Like a mirror.	0/0
1	1-3	Ripples with the appearance of scales.	0.2/0.5
2	4-6	Small wavelets; crests have a glassy appearance and do not break.	0.3/1
3	7-10	Large wavelets; crests begin to break. Foam of glassy appearance; few very scattered whitecaps.	1/2
4	11-16	Small waves, becoming larger. Fairly frequent whitecaps.	2/5
5	17-21	Moderate waves, taking a pronounced long form; many whitecaps.	3/10
6	22-27	Large waves begin to form; white foam crests are more extensive; some spray.	5/15
7	28-33	Sea heaps up and white foam from breaking waves begins to be blown in streaks along the direction of waves.	6/20
8	34-40	Moderately high waves of greater length; edges of crests break into spindrift; foam blown in well-marked streaks in the direction of the wind.	8/25
9	41-47	High waves. Dense streaks of foam; sea begins to roll; spray affects visibility.	9/30
10	48-55	Very high waves with overhanging crests; foam in great patches blown in dense white streaks. Whole surface of sea takes on white appearance. Visibility is affected.	10/35

■ **Emergency Equipment**

- No person should operate an aircraft in extended overwater operations without having the equipment listed below on the aircraft:
 - a life preserver (lifejacket) equipped with locator light and whistle for every person on board
 - enough liferafts to accommodate all of the occupants
 - at least one pyrotechnic signal device for each liferaft
 - a survival type ELT, with extra batteries
 - survival and first-aid kit attached to each required liferaft
 - an immersion suit if warranted, and if the aircraft is suitable for wearing it.
- All must be easily accessible in the event of a ditching.
- The equipment should be in conspicuously marked locations.



Appendix A – Regulation V/33 of the International Convention for the Safety of Life at Sea, 1974, as amended

Distress situations: obligations and procedures

1 The master of a ship at sea which is in a position to be able to provide assistance, on receiving information from any source that persons are in distress at sea, is bound to proceed with all speed to their assistance, if possible informing them or the search and rescue service that the ship is doing so. This obligation to provide assistance applies regardless of the nationality or status of such persons or the circumstances in which they are found. If the ship receiving the distress alert is unable or, in the special circumstances of the case, considers it unreasonable or unnecessary to proceed to their assistance, the master must enter in the log-book the reason for failing to proceed to the assistance of the persons in distress, taking into account the recommendation of the Organization to inform the appropriate search and rescue service accordingly.

1-1 Contracting Governments shall co-ordinate and co-operate to ensure that masters of ships providing assistance by embarking persons in distress at sea are released from their obligations with minimum further deviation from the ships' intended voyage, provided that releasing the master of the ship from the obligations under the current regulation does not further endanger the safety of life at sea. The Contracting Government responsible for the search and rescue region in which such assistance is rendered shall exercise primary responsibility for ensuring such co-ordination and co-operation occurs, so that survivors assisted are disembarked from the assisting ship and delivered to a place of safety, taking into account the particular circumstances of the case and guidelines developed by the Organization. In these cases the relevant Contracting Governments shall arrange for such disembarkation to be effected as soon as reasonably practicable.

2 The master of a ship in distress or the search and rescue service concerned, after consultation, so far as may be possible, with the masters of ships which answer the distress alert, has the right to requisition one or more of those ships as the master of the ship in

distress or the search and rescue service considers best able to render assistance, and it shall be the duty of the master or masters of the ship or ships requisitioned to comply with the requisition by continuing to proceed with all speed to the assistance of persons in distress.

3 Masters of ships shall be released from the obligation imposed by paragraph 1 on learning that their ships have not been requisitioned and that one or more other ships have been requisitioned and are complying with the requisition. This decision shall, if possible, be communicated to the other requisitioned ships and to the search and rescue service.

4 The master of a ship shall be released from the obligation imposed by paragraph 1 and, if his ship has been requisitioned, from the obligation imposed by paragraph 2 on being informed by the persons in distress or by the search and rescue service or by the master of another ship which has reached such persons that assistance is no longer necessary.

5 The provisions of this regulation do not prejudice the Convention for the Unification of Certain Rules of Law Relating to Assistance and Salvage at Sea, signed at Brussels on 23 September 1910, particularly the obligation to render assistance imposed by article 11 of that Convention.

6 Masters of ships who have embarked persons in distress at sea shall treat them with humanity, within the capabilities and limitations of the ship.

Appendix B – Search Action Message

Sample search action message:

FROM SANJUANSARCOORD SAN JUAN PUERTO RICO
TO M/V DEVON PACIFIC/GKXB
M/V KAPTAN BRANDT/SVCL
BT

DISTRESS N999EJ (US) DITCHED EASTERN CARIBBEAN

SEARCH ACTION PLAN FOR 15 SEPTEMBER 1996

1. SITUATION:

A. US REGISTERED AIRCRAFT N999EJ REPORTED ENGINE FAILURE AND INTENTIONS TO DITCH NEAR 14-20N 64-20W AT 152200Z

B. CESSNA CITATION III, WHITE WITH BLUE TRIM

C. FOUR PERSONS ON BOARD

D. PRIMARY SEARCH OBJECTS: 8-PERSON ORANGE RAFT WITH CANOPY, FLARES. SECONDARY: PERSONS IN THE WATER, DEBRIS, MIRROR, ORANGE SMOKE

2. ACTION: REQUEST M/V DEVON PACIFIC AND M/V KAPTAN BRANDT DIVERT TO SEARCH FOR SURVIVORS

3. SEARCH AREAS: (READ IN TWO COLUMNS)

AREA CORNER POINTS

A-1 14-11N 64-35W, 14-20N 64-35W, 14-20N 64-15W, 14-11N 64-15W

A-2 14-20N 64-35W, 14-29N 64-35W, 14-29N 64-15W, 14-20N 64-15W

4. EXECUTION: (READ IN FIVE COLUMNS)

AREA	FACILITY	PATTERN	CREEP	CSP
A-1	DEVON PACIFIC	PS	180T	14-18.5N 64-33.5W
A-2	KAPTAN BRANDT	PS	000T	14-21.5N 64-33.5W

Appendix B - Search Action Message

5. CO-ORDINATION:

- A. SAN JUAN SAR CO-ORDINATOR IS SMC.
- B. M/V DEVON PACIFIC/GKXB DESIGNATED OSC.
- C. COMMENCE SEARCH UPON ARRIVAL ON-SCENE.
- D. TRACK SPACING 3 NM DESIRED.

6. COMMUNICATIONS:

- A. CONTROL: INMARSAT.
- B. ON-SCENE: PRIMARY SECONDARY
 VHF-FM CH 23A CH 16.

7. REPORTS:

- A. OSC SEND SITREP TO SMC UPON ARRIVAL ON-SCENE THEN HOURLY THEREAFTER. INCLUDE WEATHER, SEAS, ETC. FOR EACH AREA IN ALL SITREPS.
- B. OSC REPORT ACTUAL AREA SEARCHED (SQUARE NAUTICAL MILES), HOURS SEARCHED, TRACK SPACING USED, CORNER POINTS OF ACTUAL AREAS SEARCHED IF DIFFERENT FROM THOSE ASSIGNED. SEND REPORTS VIA MOST RAPID MEANS.

BT

Appendix C – Factors Affecting Observer Effectiveness

Limitations of the eye

The human eye is complex. Its function is to receive images and transmit them to the brain for recognition and storage.

- About 80% of information intake is through the eyes.
- The eye is our prime means of identifying what is going on around us.
- An observer's basic understanding of the eyes' limitations in search object detection is useful for an effective search.
- Vision is vulnerable to many things:
 - dust
 - fatigue
 - emotion
 - germs
 - fallen eyelashes
 - age
 - optical illusions
 - effect of alcohol
 - certain medications.
- In flight, vision is influenced by
 - vibrations
 - atmospheric conditions
 - glare
 - lighting
 - windscreen distortion
 - aircraft design
 - cabin temperature
 - oxygen supply
 - acceleration forces.

Appendix C – Factors Affecting Observer Effectiveness

- Most importantly, the eye is vulnerable to the vagaries of the mind.
 - we can “see” and identify only what our mind permits us to see.
- One inherent problem with the eye is the time required for accommodation or refocusing.
 - eyes automatically accommodate for near and far objects, but to change from focusing on something close to something distant may take one to two seconds.
- Another focusing problem usually occurs when there is nothing specifically to focus on, which happens at high altitudes but also at lower levels, particularly over still water and over unbroken snow.
- To actually accept what we see, we need to receive cues from both eyes.
 - if a target is visible to only one eye, but hidden from the other by an obstruction, the total image is blurred and not always acceptable to the mind
 - observers should move their heads when scanning around obstructions.
- Although eyes accept light rays from a wide arc of vision, they are limited to a relatively narrow field of view within which they can actually focus on and classify an object.
 - movement on the periphery can be perceived, but cannot be identified, because the mind tends not to believe what peripheral vision detects, which leads to “tunnel” vision
 - motion or contrast is needed to attract the eyes’ attention.
- The eye is also severely limited by environment.
 - optical properties of the atmosphere alter the appearance of objects, particularly on hazy days
 - glare, usually worse on a sunny day, makes targets hard to see and scanning uncomfortable
 - an object with a high degree of contrast against the background will be easier to see while one with low contrast at the same distance may be impossible to see
 - when the sun is behind the observer, an object may stand out clearly, but looking into the sun, the glare will sometimes prevent seeing the object.

- Since observers tend to over-estimate their visual abilities, the best way to perform an effective visual search is to learn efficient scanning techniques.

Visual scanning technique

A system should be agreed upon in advance where the observers each scan a sector with sufficient overlap to ensure that an object is not passed undetected.

- Effective scanning is accomplished by a series of short, regularly spaced eye movements that bring successive areas of the ground or water into the central visual field.
- Each movement should not exceed 10°.
- Each area should be observed for at least two seconds (plus time to refocus if necessary).
- Although horizontal back-and-forth movements are preferred by most observers, each observer should develop the scanning pattern that is most comfortable and then adhere to it.
- Two effective scanning patterns involve the “block” system.
 - the viewing area (windscreen) is divided into segments and the observer methodically scans for the search object in each block in sequential order
 - side-to-side scanning method
 - start at the far left of the visual area
 - make a methodical sweep to the right
 - pause very briefly in each viewing block to focus the eyes
 - at the end of the scan, repeat
 - front-to-side scanning method
 - start in the centre block of the assigned search sector
 - move to the left
 - focus briefly in each block
 - swing quickly back to the centre after reaching the last block on the left
 - repeat the performance to the right
 - swing quickly back to the centre, etc.

Appendix C - Factors Affecting Observer Effectiveness

Note: The pilot flying a search aircraft would, at the end of the outside scan, scan the instrument panel, then repeat the external scan. (The pilot should note the need to refocus after the instrument scan.)

- Side observers in aircraft should scan from bottom to top and then top to bottom to avoid longer times for refocusing and allow the forward motion of the aircraft to move their field of vision along the track.

Appendix D – Standard Format for Search and Rescue Situation Report (SITREP)

Situation reports (SITREPs) should be compiled as follows:

Short Form

To pass urgent essential details when requesting assistance, or to provide the earliest notice of a casualty.

Transmission priority (distress/urgency, etc.): _____

Date and time (UTC or local date time group): _____

From (originating RCC): _____

To: _____

SAR SITREP (number) (to indicate nature of message and completeness of sequence of SITREPs concerning the casualty): _____

Identity of casualty (name, call sign, flag State): _____

Position (latitude/longitude): _____

Situation (type of message, distress or urgency; date/time; nature of distress/urgency, for example, fire, collision, medical): _____

Number of persons at risk: _____

Assistance required: _____

Co-ordinating RCC: _____

Full Form

To pass amplifying or updating information during SAR operations, the following additional sections should be used as required:

Description of casualty (physical description, owner/charterer, cargo carried, passage from/to, life-saving appliances carried, etc.): _____

Weather on-scene (wind, sea/swell state, air/sea temperature, visibility, cloud cover/ceiling, barometric pressure): _____

Initial actions taken (by distressed craft and RCC): _____

Search area (as planned by RCC): _____

Co-ordinating instructions (OSC designated, units participating, communications, etc.): _____

Future plans: _____

Additional information/conclusion (include time SAR operation terminated): _____

- Note 1. *Each SITREP concerning the same casualty should be numbered sequentially.*
- Note 2. *If help is required from the addressee, the first SITREP should be issued in short form if remaining information is not readily available.*
- Note 3. *When time permits, the full form may be used for the first SITREP or to amplify it.*
- Note 4. *Further SITREPs should be issued as soon as other relevant information has been obtained, particularly changes to on-scene weather. Information already passed should not need repetition.*
- Note 5. *During prolonged operations "no change" SITREPs, when appropriate, should be issued at intervals of about three hours to reassure the recipients that nothing has been missed.*
- Note 6. *When the incident has been concluded, a final SITREP should be issued as confirmation.*

Appendix E – SAR Briefing and Debriefing Form

Briefing

SAR: _____

Date: _____

Search Craft Number: _____ Unit: _____

Captain: _____

Details as to nature of distress or emergency: _____

Description of search object

Type of aircraft or vessel: _____

Number or name of craft: _____

Length: _____ Width (Wing-span): _____

Number on board: _____

Full description of craft, including colour and markings: _____

Frequencies of missing craft: _____

Assigned search areas

Area: _____

Type of search: _____

Altitude/Visibility: _____ Time on task: _____

Commence search at (position): _____
and track (N-S) (E-W) _____

Frequencies: _____

Co-ordinating Agency: _____ Aircraft: _____

Surface vessels: _____ Others: _____

Progress reports

To be passed to: _____ every _____ hours
with weather report included every _____ hours.

Special instructions

Debriefing

SAR: _____

Search craft: _____ Date: _____

Point of departure: _____

Point of landing: _____

Time off: _____ On task: _____ Off task: _____ Landed: _____

Area actually searched: _____

Type of search: _____ Altitude/Visibility: _____

Terrain or sea state: _____ Number of observers: _____

Weather conditions in search area (visibility, wind velocity,
ceiling, etc.) _____

Object of search: (located) at position: _____

Number and condition of survivors: _____

Sightings and/or other reports: _____

Telecommunications: (Note quality of communications and/or
any changes other than briefed) _____

Remarks: (To include any action taken on search,
any problems, criticism, suggestions) _____

Date: _____ Name: _____

○

○

○